



# Service / Training Manual

High Speed Combination Oven



ACE / MCE - 60 Hz  
October 2012  
16400018

© / ™ © 2012 Amana. All rights reserved. Brand used under license..



# Table of Contents

Important Safety Information.....	1-5
Installation.....	7
Specifications.....	8
Quick Start Reference Guide ACE14 / MCE14.....	9-17
Oven Construction ACE14 / MCE14.....	18-21
Oven Performance Test ACE14 / MCE14.....	22
Component Testing Procedures ACE14 / MCE14.....	23-27
Service Test ACE14 / MCE14.....	28-31
Test Modes.....	32
Display Diagnostics ACE14 / MCE14.....	33
Wiring Diagrams / Schematics Sample ACE14 / MCE14.....	34-36

# **1** | **Important Safety Information**

# Important Information

## Important Notices for Servicers and Consumers

ACP will not be responsible for personal injury or property damage from improper service procedures. Pride and workmanship go into every product to provide our customers with quality products. It is possible, however, that during its lifetime a product may require service. Products should be serviced only by a qualified service technician who is familiar with the safety procedures required in the repair and who is equipped with the proper tools, parts, testing instruments and the appropriate service information. IT IS THE TECHNICIANS RESPONSIBILITY TO REVIEW ALL APPROPRIATE SERVICE INFORMATION BEFORE BEGINNING REPAIRS.

 <b>WARNING</b>
To avoid risk of severe personal injury or death, disconnect power before working/servicing on appliance to avoid electrical shock.

To locate an authorized servicer please contact:

ComServ Support Center



Web Site  
WWW.ACPSOLUTIONS.COM

Telephone Number  
..... 1-866-426-2621 or 319-368-8195

E-Mail: [commercialservice@acpsolutions.com](mailto:commercialservice@acpsolutions.com)

Recognize Safety Symbols, Words, and Labels

 <b>DANGER</b>
---

DANGER— Immediate hazards which WILL result in severe personal injury or death.

 <b>WARNING</b>
--

WARNING— Hazards or unsafe practices which COULD result in severe personal injury or death.

 <b>CAUTION</b>
--

CAUTION— Hazards or unsafe practices which COULD result in minor personal injury, product or property damage.

# Important Safety Information



## WARNING

Read the following information to avoid possible exposure to microwave radiation:

The basic design of the Microwave Oven makes it an inherently safe device to both use and service.

However, there are some precautions which should be followed when servicing the microwave to maintain this safety. These are as follows:

1. Always operate the unit from an adequately grounded outlet. Do not operate on a two-wire extension cord.
2. Before servicing the unit (if unit is operable) perform the microwave leakage test.
3. The oven should never be operated if the door does not fit properly against the seal, the hinges or hinge bearings are damaged or broken; the choke is damaged, (pieces missing, etc.); or any other visible damage can be noted. Check the choke area to ensure that this area is clean and free of all foreign matter.
4. If the oven operates with the door open and produces microwave energy, take the following steps:
  - A. Tell the user not to operate the oven.
  - B. Contact ACP ComServ immediately.
5. Always have the oven disconnected when the outer case is removed except when making the "live" tests called for in the Service Manual. Do not reach into the equipment area while the unit is energized. Make all connections for the test and check them for tightness before plugging the cord into the outlet.
6. Always ground the capacitors on the magnetron filter box with an insulated-handle screwdriver before working in the high voltage area of the equipment compartment. Some types of failures will leave a charge in these capacitors and the discharge could cause a reflex action which could make you injure yourself.
7. Always remember that in the area of the transformer there is HIGH VOLTAGE. When the unit is operating keep this area clear and free of anything which could possibly cause an arc or ground, etc.
8. Do not for any reason defeat the interlock switches there is not valid reason for this action at any time; nor will it be condoned by ACP.
9. IMPORTANT: Before returning a unit to a customer, be sure to check for proper switch interlock action.
10. The Microwave Oven should never be operated with any components removed and/or bypassed or when any of the safety interlocks are found to be defective, or when any of the seal surfaces are defective, missing, or damaged.
11. All microwave ovens meet all requirements of the radiation control for Health and Safety Act of 1968. Due to measurement uncertainties, the maximum leakage for the field will be  $4\text{mw}/\text{cm}^2$ .
12. To ensure that the unit does not emit excessive microwave leakage and to meet the Department of Health and Human Services guidelines, check the oven for microwave leakage using a microwave oven leakage meter that complies with US Government CDRH / FDA / DHHS requirements and or any other local government requirements. The maximum leakage level allowed by ACP is  $4\text{mw}/\text{cm}^2$ .
13. If servicer encounters an emission reading over  $4\text{mw}/\text{cm}^2$ , the servicer is to cease repair and contact the ACP ComServ Department immediately for further direction. ACP will contact the proper Government Agency upon verification of the test results.

# IMPORTANT SAFETY INSTRUCTIONS



Recognize this symbol as a **SAFETY** message



## WARNING

When using electrical equipment, basic safety precautions should be followed to reduce the risk of burns, electrical shock, fire, or injury to persons including the following.

1. READ all instructions before using equipment.
2. READ AND FOLLOW the specific “PRECAUTIONS TO AVOID POSSIBLE EXPOSURE TO EXCESSIVE MICROWAVE ENERGY” on this page.
3. This equipment **MUST BE GROUNDED**. Connect only to properly **GROUNDED** outlet. See “**GROUNDDING / EARTHING INSTRUCTIONS**” on page 5.
4. Install or locate this equipment **ONLY** in accordance with the installation instructions in this manual.
5. Some products such as whole eggs and sealed containers—for example, closed glass jars—are able to explode and **SHOULD NOT** be **HEATED** in this oven.
6. Use this equipment **ONLY** for its intended use as described in this manual. Do not use corrosive chemicals or vapors in this equipment. This type of oven is specifically designed to heat, cook, or dry food. It is not designed for industrial or laboratory use.
7. As with any equipment, **CLOSE SUPERVISION** is necessary when used by **CHILDREN**.
8. See door cleaning instructions on page A-4 of this owners manual.
9. **DO NOT** heat baby bottles in oven.
10. Baby food jars shall be open when heated and contents stirred or shaken before consumption, in order to avoid burns.
11. **DO NOT** operate this equipment if it has a damaged cord or plug, if it is not working properly, or if it has been damaged or dropped.
12. This equipment, including power cord, must be serviced **ONLY** by qualified service personnel. Special tools are required to service equipment. Contact nearest authorized service facility for examination, repair, or adjustment.
13. **DO NOT** cover or block louvers or other openings on equipment.
14. **DO NOT** store this equipment outdoors. **DO NOT** use this product near water – for example, near a kitchen sink, in a wet basement, a swimming pool, or a similar location.
15. **DO NOT** immerse cord or plug in water.
16. Keep cord **AWAY** from **HEATED** surfaces.
17. **DO NOT** let cord hang over edge of table or counter.
18. For commercial use only.

## PRECAUTIONS TO AVOID POSSIBLE EXPOSURE TO EXCESSIVE MICROWAVE ENERGY

- A. **DO NOT** attempt to operate this oven with the door open since open door operation can result in harmful exposure to microwave energy. It is important not to defeat or tamper with the safety interlocks.
- B. **DO NOT** place any object between the oven front face and the door too allow soil or cleaner residue to accumulate on sealing surfaces.
- C. **DO NOT** operate the oven if it is damaged. It is particularly important that the oven door close properly and that there is no damage to the:
  1. door (bent)
  2. hinges and latches (broken or loosened)
  3. door seals and sealing surfaces.
- D. The oven should not be adjusted or repaired by anyone except properly qualified service personnel.

## SAVE THESE INSTRUCTIONS

# IMPORTANT SAFETY INSTRUCTIONS



## WARNING

To avoid risk of fire in the oven cavity:

- a. DO NOT overcook food. Carefully attend oven when paper, plastic, or other combustible materials are placed inside the oven to facilitate cooking.
- b. Remove wire twist-ties from paper or plastic bags before placing bag in oven.
- c. If materials inside the oven ignite, keep oven door CLOSED, turn oven off and disconnect the power cord, or shut off power at the fuse or circuit breaker panel.
- d. DO NOT use the cavity for storage. DO NOT leave paper products, cooking utensils, or food in the cavity when not in use.



## WARNING

Liquids such as water, coffee, or tea are able to be overheated beyond the boiling point without appearing to be boiling due to surface tension of the liquid. Visible bubbling or boiling when the container is removed from the microwave oven is not always present. THIS COULD RESULT IN VERY HOT LIQUIDS SUDDENLY BOILING OVER WHEN A SPOON OR OTHER UTENSIL IS INSERTED INTO THE LIQUID. To reduce the risk of injury to persons:

- i) Do not overheat the liquid.
- ii) Stir the liquid both before and halfway through heating it.
- iii) Do not use straight-sided containers with narrow necks.
- iv) After heating, allow the container to stand in the microwave oven for a short time before removing the container.
- v) Use extreme care when inserting a spoon or other utensil into the container.



## CAUTION

To avoid personal injury or property damage, observe the following:

1. Do not deep fat fry in oven. Fat could overheat and be hazardous to handle.
2. Do not cook or reheat eggs in shell or with an unbroken yolk using microwave energy. Pressure may build up and erupt. Pierce yolk with fork or knife before cooking.
3. Pierce skin of potatoes, tomatoes, and similar foods before cooking with microwave energy. When skin is pierced, steam escapes evenly.
4. Do not operate equipment without load or food in oven cavity.
5. Microwave popcorn should not be popped in oven.
6. Do not use regular cooking thermometers in oven. Most cooking thermometers contain mercury and may cause an electrical arc, malfunction, or damage to oven.
7. Do not use metal utensils in oven.
8. Do not use aluminum foil in oven
9. Never use paper, plastic, or other combustible materials that are not intended for cooking.
10. When cooking with paper, plastic, or other combustible materials, follow manufacturer's recommendations on product use.
11. Do not use paper towels which contain nylon or other synthetic fibers. Heated synthetics could melt and cause paper to ignite.
12. Do not heat sealed containers or plastic bags in oven. Food or liquid could expand quickly and cause container or bag to break. Pierce or open container or bag before heating.
13. To avoid pacemaker malfunction, consult physician or pacemaker manufacturer about effects of microwave energy on pacemaker.
14. An authorized servicer MUST inspect equipment annually. Record all inspections and repairs for future use.

## SAVE THESE INSTRUCTIONS

# 2

## **ACE14 / MCE14 60 Hz Specifications**

### **Installation**

- Unpacking the oven
- Oven Clearances

### **Power Specification**

- Input
- Output
- Consumption

### **Dimensions**

- Weight

# Installation

## STEP 1 - Unpack Oven

- Inspect oven for damage such as dents in door or inside oven cavity.
- Report any dents or breakage to source of purchase immediately.  
**Do not attempt to use oven if damaged.**
- Remove all packing materials from oven interior.
- If oven has been stored in extremely cold area, wait a few hours before connecting power.

## STEP 2 - Place Oven on Counter

- Do not install oven next to or above source of heat, such as pizza oven or deep fat fryer. This could cause microwave oven to operate improperly and could shorten life of electrical parts.
- Do not block or obstruct oven filter. Allow access for cleaning.
- Install oven on level countertop surface.
- Place warning label in a conspicuous place close to microwave oven.
- Outlet should be located so that plug is accessible when oven is in place.

## STEP 3 - Install Rack

- Install oven rack
  1. Oven cavity must be cool to touch.
  2. Place rack in oven with rear guard positioned toward the back of the oven.
- **DO NOT** cook food directly on floor of oven.

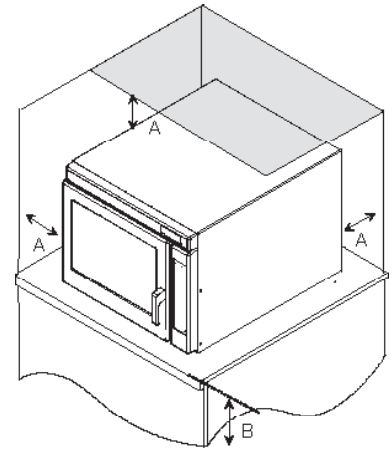

### Oven Clearances

A—Allow at least 1 1/4" (3.18 cm) of clearance around top and sides of oven. Proper air flow around oven cools electrical components. With restricted air flow, oven may not operate properly and life of electrical parts is reduced.

B—Install combination oven so oven bottom is at least 3 feet (91.5 cm) above floor.

# Specifications ACE14 / MCE14

Models	ACE14* / MCE14*
<b>Power Source</b>	
Voltage AC	230 VAC
Amperage (Single Unit)	20 A
Frequency	60 Hz
Single Phase, 3 wire grounded	X
Receptacle	6-20R
Plug	6-20P
<b>Power Output – Microwave</b>	
Nominal microwave energy (IEC705)	1400 Watts
Minimum temperature rise ( $\Delta T$ )	10°F / 5°C
Operating Frequency	2450 MHz
<b>Power Consumption</b>	
Microwave only	2200 Watts
Convection only	2700 Watts
Combination	5700 Watts
<b>Dimensions</b>	
<b>Cabinet (in / cm)</b>	
Width	19 3/4" 50 cm
Height	18 1/8" 46 cm
Depth	26 1/4" 54 cm
<b>Oven Interior (in / cm)</b>	
Width	13" 33 cm
Height	10 1/2" 27 cm
Depth	15" 38 cm
<b>Weight</b>	
Crated	102 lbs. 46 kg.
Uncrated	95 lbs. 43 kg.
EZ Card Menu Management	X

# **3** | **ACE14 / MCE14** **60 Hz Quick Start** **Reference Guide**

# ACE14 / MCE14

## Display and Features

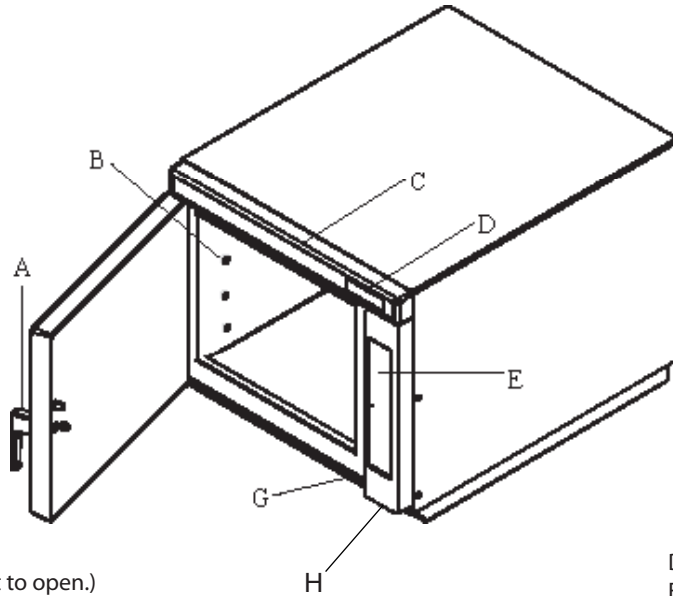

A—Oven Door Handle (Lift to open.)  
B—Rack Guides  
C—Top Control Panel

D—Display  
E—Side Control Panel  
G—Air Intake Filter (some models)  
H—EZ Card Slot

---

### Oven Features

Standby shows in display after oven door has been opened and closed, or after turning oven OFF with the Preheat On/Off pad.

**Standby**

**Oven Preheating**  
**450°F**

Oven Preheating and set temperature shows in display after pressing Preheat On/Off pad. (example of 450°F shown)

## Display and Features (cont'd)

Ready and set temperature displays after pressing Preheat On/Off pad. Ready indicates the oven is up to temperature. (example of 450°F shown)



Ready  
450°F

Indicates oven is in a preprogrammed cooking program



Item-05      Stage:1  
01:23 450°F MW:50%

Cooking information shows in display after pressing a single (or double) digit pad while in Ready Mode.

Time left  
in cooking  
program

Cooking  
temperature

Percentage  
of microwave  
power

Indicates oven is in a manual cooking program



Manual      Stage: 1  
00:15 475°F MW:100%

Time left  
in cooking  
condition

Cooking  
temperature

Indicates  
percentage  
of microwave  
power

# ACE14 / MCE14

## Display and Features (cont'd)

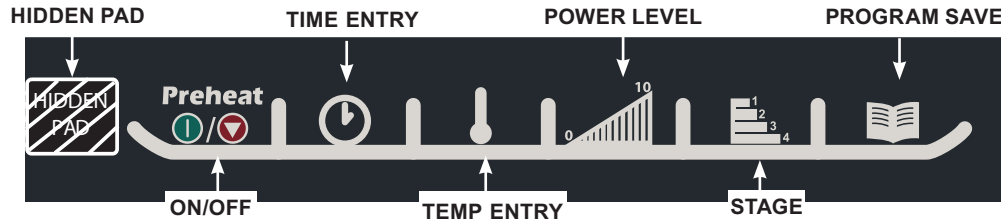

### Cooking Display



#### Start pad

The Start pad is used to begin a manual time entry cooking cycle.



#### Stop/Reset pad

The Stop/Reset pad stops a cooking sequence in progress, clears out any remaining time, and also ends a programming or user option cycle. When the Stop/Reset pad is used to end a programming or option change, the changes are discarded.

### Temperature warnings

The combination oven has two distinct temperature warnings. Warnings sound with a three beep signal when a programmed pad is pressed. Warnings are:

- A warning when the preheat temperature does not match the preprogrammed temperature of a cooking condition.
- A warning when the actual oven cavity temperature is not to preheat temperature, such as when the oven is first started.

To override the warning and begin a cooking cycle, press the Start pad. To turn off warnings, see *User Options* section.

#### DISPLAYS

#### DESCRIPTION

**OVEN PREHEATING 450°F**

**Oven Preheating 450°F** displays when oven is turned on and is warming up to the selected preheat temperature. **Oven Preheating** also flashes when a cooking condition can be started or programmed. (example of 450°F shown)

**READY 450°F**

**Ready 450°F** displays when oven has reached preheat temperature and is ready to cook. **Ready** also flashes when a cooking condition can be started or programmed. (example of 450°F shown)

**Note:** Oven will shutdown after two hours of inactivity.

**00:00**

Displays cooking time. If stage cooking is programmed, total cooking time is displayed

**MW 50%**

**MW 50%** displays the current microwave power level. 100% is the highest setting, and 0% is lowest (no microwave energy used). (example of 50% shown)

**ITEM-05**

**ITEM-05** displays the single or double digit entry of a programmed cooking condition when using a programmed pad. (example of Item 05 shown)

**STAGE 1**

**Stage 1** displays to show the stage number (1 through 4) the oven is at in the cooking condition

**STANDBY**

**STANDBY** displays when oven is turned off, and also after the oven is plugged in, the door is opened, and then shut.

### Programming Display

#### DISPLAYS

#### DESCRIPTION

**Enter Program to Add/Review:**







Displays when oven is in programming mode for single pad or double pad memory.

**STAGE 1**

Displays stage number during cooking or when programming a specific cooking stage. Stage number (1 through 4) indicates the stage that is being used.



## Programming Pads

Oven is shipped from the factory for single pad programming. To change the oven default to double pad programming, see *User Option* section. To program the amount of time, power level, or temperature setting for a pad:

1. Oven must be ON.
  - Press Preheat On/Off pad.
  - **Oven Preheating 450°F** shows in display with **Oven Preheating** flashing. (example of 450°F shown) 
2. Oven reaches preheat temperature.
  - Signal sounds and **Ready 450°F** shows in display with **Ready** flashing. (example of 450°F shown)
2. Press Program Save pad.
  - Programming mode begins.
  - **Enter Program to Add/Review:** shows in display. 
3. Press pad to be programmed or reprogrammed.
  - Display will change to review all settings for the pad.
  - The pad number that is being programmed displays beside the word **ITEM**.
4. Press Time Entry pad to program amount of cooking time.
  - Enter desired cooking time by using numeric key pads.
  - The total microwave cooking time (all stages combined) is 20 minutes. 
5. Press Temp Entry pad to program the cooking temperature.
  - Enter desired convection temperature by using numeric pads. 
6. Press Power Level pad to program level of microwave power.
  - Press numeric key pad for desired level. Press numeric key pad again to set power level to 100%. 
  - For a lower microwave power, press pads 1 (for 10%) through 9 (for 90%). **0 turns off the microwave power and cooking is by convection only.**
7. Press Program Save pad to save the program changes. 
8. To discard changes, press Stop/Reset pad.

## Programming Multiple Stages

Stage cooking allows consecutive cooking cycles without interruption. Up to four different cooking cycles can be programmed into a memory pad. To use stage cooking:

1. Follow steps 1 through 6 above.
7. Press Stage pad.
  - This will begin programming for the next cooking stage. 
  - Display indicates stage to be programmed.
  - Enter cook time, temp and power level as in steps 4. 5 and 6.
  - To enter another cooking stage for that pad, press Stage pad again.
  - Up to four different stages can be programmed.
8. Press Program Save pad to save the program and changes. 
9. To discard changes, press Stop/Reset pad before pressing Program Save pad.

## Programming Preheat Setting

The convection temperature setting can be set between 150°F to 475°F (65°C to 250°C). It is recommended to set the preheat setting to the most commonly used temperature for that oven. The factory default preheat setting is 450°F (230°C).

**To program the preheat setting:**

1. Press Program Save pad.
2. Press Temp Entry pad.
3. Enter desired temperature by using the numeric key pads.
  - Temperature must be entered in 25°F (10°C) increments. If not, the temperature will automatically change to the nearest 25°F (10°C).
4. Preheat temperature is changed



## What is stage cooking?

Stage cooking enables several different cooking cycles, or stages, to be used consecutively without repeated input from the user. Stage cooking can be set to defrost food initially, then cook it, and then keep the food warm until serving time.

Example of Stage Cooking Conditions

	Stage 1	Stage 2	Stage 3	Stage 4
<b>Temp</b>	450°F	450°F	450°F	450°F
<b>Power</b>	100%	30%	0	50%
<b>Time</b>	2:30	1:30	1:30	1:00

## Convection Cooking



### CAUTION

To avoid risk of burns, handle utensils, racks, and door with care. Allow oven, utensils, and racks to cool before cleaning. Oven, utensils, and racks, become hot during operation.

To operate the oven for convection cooking only, you can use preprogrammed pads or manual time entry. **The following instructions are for convection cooking only.** For combination cooking, see that section.

### Convection Cooking

Convection cooking utilizes both a convection element and fan to evenly distribute heated air throughout the oven cavity. By circulating air, no hot or cold spots occur, creating a consistent temperature envelope around the food. These consistent temperatures cook food evenly and reduces cooking time. Oven will always operate in convection mode.

#### Convection Cooking with Programmed Pads

1. Press Preheat On/Off pad to start the oven.
  - Oven begins a preheat cycle.
  - **Oven Preheating 450°F** shows in display. (example of 450°F shown)
  - To change preheat temperature, see *Programming*.
2. Oven reaches preheat temperature.
  - Signal sounds and **Ready 450°F** displays.
3. Press selected pad.
  - If using single pad programming, press pad and oven begins automatically.
  - For double pad programming, press pads in proper sequence and oven begins automatically.
4. Cooking cycle begins
  - Preprogrammed cooking program, total cooking time, cooking temperature, percentage of microwave power, and stage are all displayed.
5. Oven finishes cooking sequence
  - An end of cycle beep signals the end of the cooking cycle.
  - **Done** shows in display.
  - **Oven interior and cooking dish will be hot.**
6. Press Preheat On/Off pad to shut off oven.



#### Convection Cooking Using Manual Cooking Operation

1. Press Preheat On/Off pad to start the oven.
  - Oven begins a preheat cycle.
  - **Oven Preheating 450°F** shows in display. (example of 450°F shown)
  - To change preheat temperature, see *Programming*.
2. Oven reaches preheat temperature.
  - Signal sounds and **Ready 450°F** displays.
3. Place food in the oven.
4. Press Time Entry pad.
  - Enter desired cooking time by using the numeric keypad.
5. Press Temp Entry pad if cooking temperature differs from preheat temperature.
  - Enter the new temperature.
6. Press Power Level pad.
  - Press numeric key pad for desired level. Press numeric key pad again to set power level to 100%.
  - For a lower microwave power, press pads 1 (for 10%) through 9 (for 90%). **0 turns off the microwave power and cooking is by convection only.**
7. If stage cooking is desired, press Stage pad and repeat steps 3, 4, and 5.
  - Up to 4 different stages can be programmed.
8. Press the Start pad to begin the cooking cycle.

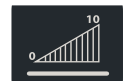

# Combination Cooking (microwave and convection)



## CAUTION

To avoid risk of burns, handle utensils, racks, and door with care. Allow oven, utensils, and racks to cool before cleaning. Oven, utensils, and racks, become hot during operation.

To operate the oven for combination cooking, you can use preprogrammed pads or manual time entry. **The following instructions are for combination cooking only.** For convection only cooking, see that section.

### Combination Cooking With Preprogrammed Pads

1. Press Preheat On/Off pad to start the oven.
  - Oven begins a preheat cycle.
  - **Oven Preheating 450°F** shows in display. (example of 450°F shown)
  - To change preheat temperature, see *Programming*.
2. Oven reaches preheat temperature.
  - Signal sounds and **Ready 450°F** displays.
3. Press selected pad.
  - If using single pad programming, press pad and oven begins automatically.
  - For double pad programming, press pads in proper sequence and oven begins automatically.
4. Cooking cycle begins
  - Preprogrammed cooking program, total cooking time, cooking temperature, percentage of microwave power, and stage are all displayed.
5. Oven finishes cooking sequence
  - An end of cycle beep signals the end of the cooking cycle.
  - **Done** shows in display.
  - **Oven interior and cooking dish will be hot.**
6. Press Preheat On/Off pad to shut off oven.

Preheat



### Combination Cooking

The combination mode uses both the speed of **microwave energy** and browning of **convection** cooking to yield fast, high quality food.

- Microwave cooking uses high frequency energy waves to heat the food. When cooking, microwave energy causes food molecules to move rapidly. This rapid movement between the food molecules creates heat, which cooks the food. POWER displays when oven is generating microwave energy for the current cycle.
- Convection cooking uses the selected oven temperature to bake and brown foods. The circulating air surrounds food in an envelope of evenly heated air.
- Oven will maintain a minimum convection temperature of 65°C (150°F) to ensure drier air and more even cooking.

### Combination Cooking Using Manual Cooking Operation

1. Press Preheat On/Off pad to start the oven.
  - Oven begins a preheat cycle.
  - **Oven Preheating 450°F** shows in display. (example of 450°F shown)
  - To change preheat temperature, see *Programming*.
2. Oven reaches preheat temperature.
  - Signal sounds and **Ready 450°F** displays.
3. Press Time Entry pad.
  - Enter desired cooking time by using the numeric keypad.
4. Press Temp Entry pad if cooking temperature differs from preheat temperature.
  - Enter the new temperature.
5. Press Power Level pad.
  - Press numeric key pad for desired level. Press numeric key pad again to set power level to 100%.
  - For a lower microwave power, press pads 1 (for 10%) through 9 (for 90%). **0 turns off the microwave power and cooking is by convection only.**
6. If stage cooking is desired, press Stage pad and repeat steps 3, 4, and 5.
  - Up to 4 different stages can be programmed.
7. Press the Start pad to begin the cooking cycle.

Preheat

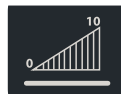

# ACE14 / MCE14

## User Options

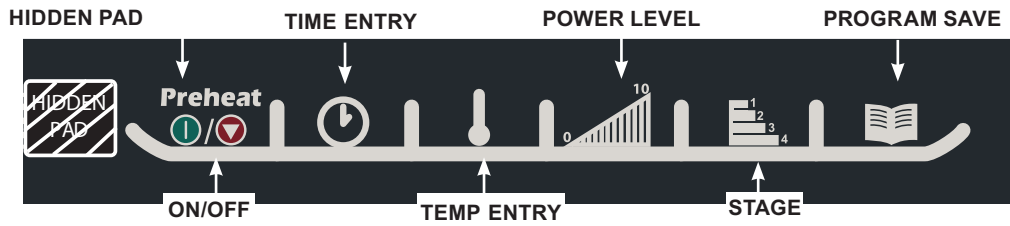

### Changing user options

Options such as single or double pad programming, beep volume, and maximum cooking time can be changed to suit individual preferences.

### Didn't like an option?

Factory settings are marked in bold. To change the oven back to the factory setting, simply select the option that is marked in bold.

**?** **My changes weren't saved.**  
In order for any changes to be saved, the Program Save pad must be pressed after selecting an option. Pressing the Stop/Reset pad will not save changes.

#### To change options oven STANDBY must display:

- Press hidden pad.
  - Pad is unmarked and located to the direct left of Preheat On/Off pad.
  - Nothing will be displayed when hidden pad is pressed.
- Press Program Save pad.
  - The first user option will display. Oven is now in options mode.
- Press number pad that controls option to be changed.
  - See table below for options.
  - Current option will display.
- Press numeric pad again to change the option.
  - Each time pad is pressed, option will change.
  - Match code displayed with code for desired option.
  - To change additional options, repeat steps 3 and 4.
  - Changes take affect after pad is pressed. Press Program Save to save.
- Press Stop/Reset pad to return to STANDBY, or open and close oven door.

Numbered Pads	Display	Options (Factory Settings in Bold)
1 Double Digit Entry	Disabled Enabled	<b>Allows 10 (0-9) preprogrammed pads.</b> Allows 100 (00-99) preprogrammed pads.
2 Manual Time Entry	Disabled Enabled	Manual time entry/cooking not allowed <b>Manual time entry/cooking allowed</b>
3 Reset on Door Open	Disabled Enabled	<b>Opening oven door does not reset oven back to ready mode</b> Opening oven door resets the oven back to ready mode
4 Keybeep	Disabled Enabled	Keys do not beep when pressed (keybeep off) <b>Keys beep when pressed (keybeep on)</b>
5 Keybeep Volume	OFF LOW MEDIUM HIGH	Keybeep volume OFF Keybeep volume LOW Keybeep volume MEDIUM <b>Keybeep volume HIGH</b>
6 End of Cook Signal	Solid Beep 3 Second Beep 4 Beeps Once 4 Beeps Repeating	Food done signal is a continuous beep until reset by user <b>Food done signal is a three second beep</b> Food done signal is four beeps, continuously Food done signal is four beeps, four times
7 Keypad Active	15 SECONDS 30 SECONDS 60 SECONDS 120 SECONDS ALWAYS	Keypad time entry window is 15 seconds Keypad time entry window is 30 seconds <b>Keypad time entry window is one minute</b> Keypad time entry window is two minutes Keypad time entry window is always active
8 Preheat Warnings	Disabled Program Temp Cavity Temp Both	<b>Both temperature warnings off</b> Warning only when preheat temperature does not match preprogrammed temperature Warning only when actual oven cavity temperature is not to preheat temperature Both temperature warnings on
TEMP PAD Temperature Scale	Degrees F Degrees C	Temperatures are displayed in °F for 60 Hz models Temperatures are displayed in °C for 50 Hz models
CLEAN FILTER Message Frequency	Disabled Weekly Monthly Quarterly	Oven will not display Clean Filter <b>Oven will display Clean Filter every seven (7) days</b> Oven will display Clean Filter every thirty (30) days Oven will display Clean Filter every ninety (90) days

# EZCard Operating Instructions (some models)



**Update  
programs in  
seconds!**

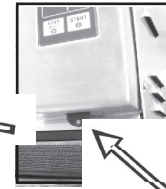

EZCard slot

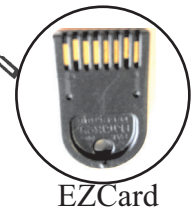

EZCard

**To program the oven using the EZCard:  
Oven must be in Standby mode (Preheat must be OFF)**

1. Remove protective cover from bottom of vertical keypad.
2. Insert the EZCard into the slot located below the vertical keypad.
  - The EZCard can be inserted forwards or backwards.
3. Open and close door.
4. Press and hold the Program Save pad for 3 seconds.
  - **AUTO**, then **PROG** displays briefly, repeating this sequence every second as the EZCard automatically programs the oven.
  - When the oven programming is complete, **DONE** shows in the display for 3 seconds and the oven beeps.
  - The oven resets to the standby mode.
5. Remove the EZCard.
  - The oven programming is now complete.
6. Place protective cover back over slot in bottom of control panel.

**Caution:**  
DO NOT REMOVE EZCard while programming. Removing card during programming can cause the oven's keypad to freeze up.

**NOTE:** If 00:00 displays, 3 beeps sound and the display returns to the Standby mode, the EZCard was not detected.

- Reinsert the EZCard into the slot and try each step again.
- If after several attempts, the EZCard is still not detected, contact ACP ComServ Service Support.
  - **Inside** the U.S.A. or Canada, call toll-free at 866-426-2621.
  - **Outside** the U.S.A. and Canada, call 319-368-8120.
  - **Email:** [commercialservice@acpsolutions.com](mailto:commercialservice@acpsolutions.com)



Use this option only to transfer data from the oven **TO** the EZCard. **This will overwrite all programming on the EZCard!**

**To transfer programming from the oven to the EZCard:  
Oven must be in Standby mode (Preheat must be OFF)**

1. Remove protective cover from bottom of vertical keypad.
2. Insert the EZCard into the slot located below the vertical keypad.
  - The EZCard can be inserted forwards or backwards.
3. Open and close door.
4. Press the Program Save pad.
5. Press the START pad.
6. Press the 1 pad, the 3 pad, and then the 5 pad.
  - The programming transfer will begin automatically and the display will show moving dashes.
  - When the programming transfer is complete, **DONE** shows in the display for 3 seconds and the oven beeps.
  - The oven resets to the standby mode.
7. Remove the EZCard.
  - The programming transfer is now complete.
8. Place protective cover back over slot in bottom of control panel.

To order additional EZCards, call the ACP Commercial Inside Sales Team toll-free at 800-233-2366 (U.S.A. or Canada), or 319-368-8120 (outside the U.S.A. and Canada).

# **4** | **ACE14 / MCE14** **60 Hz Oven Construction**



# WARNING

To avoid risk of electrical shock, personal injury or death; disconnect power to oven and discharge capacitors before following any disassembly procedures.

## Component Location

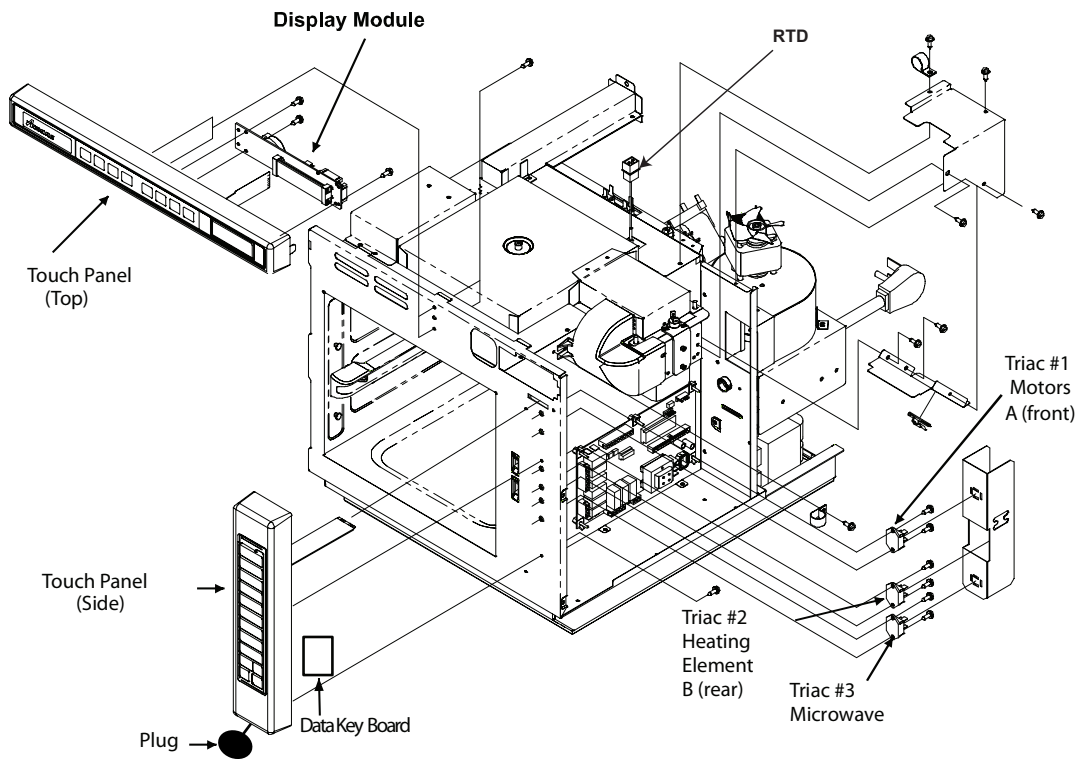

Figure 1  
Touch Panels/Displays/Triacs

**DANGER**  
High Voltage Components

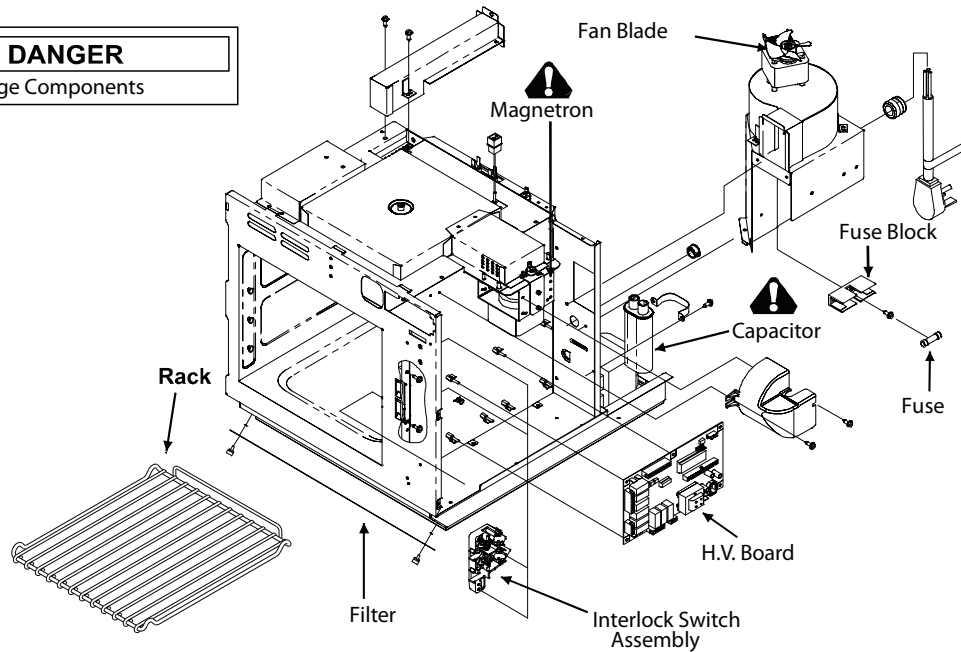

Figure 2

# Oven Construction



## WARNING

To avoid risk of electrical shock, personal injury or death; disconnect power to oven and discharge capacitors before following any disassembly procedures.

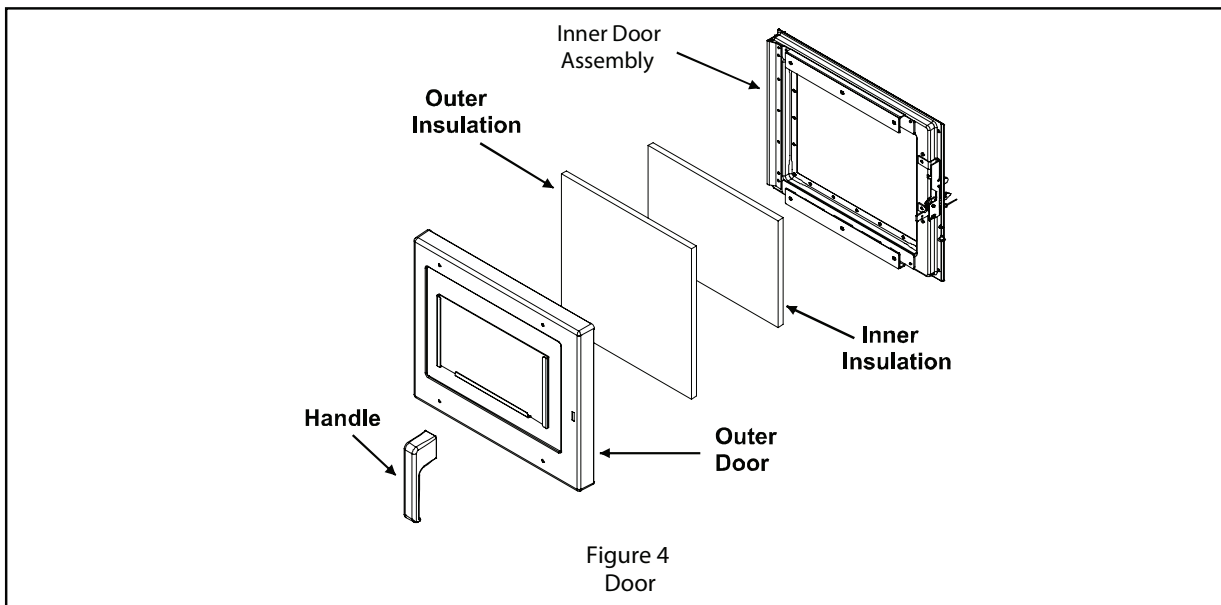
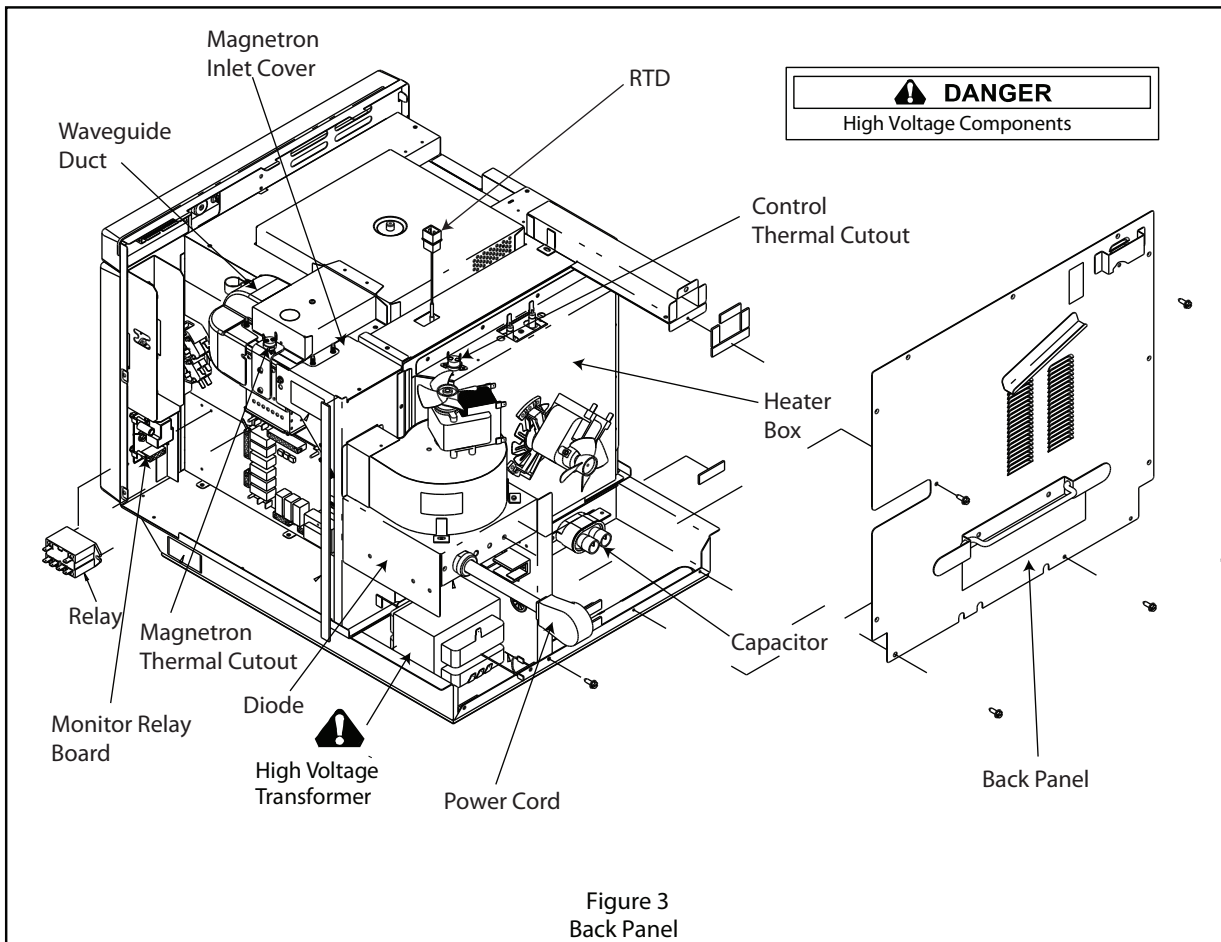

# Oven Construction



## WARNING

To avoid risk of electrical shock, personal injury or death; disconnect power to oven and discharge capacitors before following any disassembly procedures.

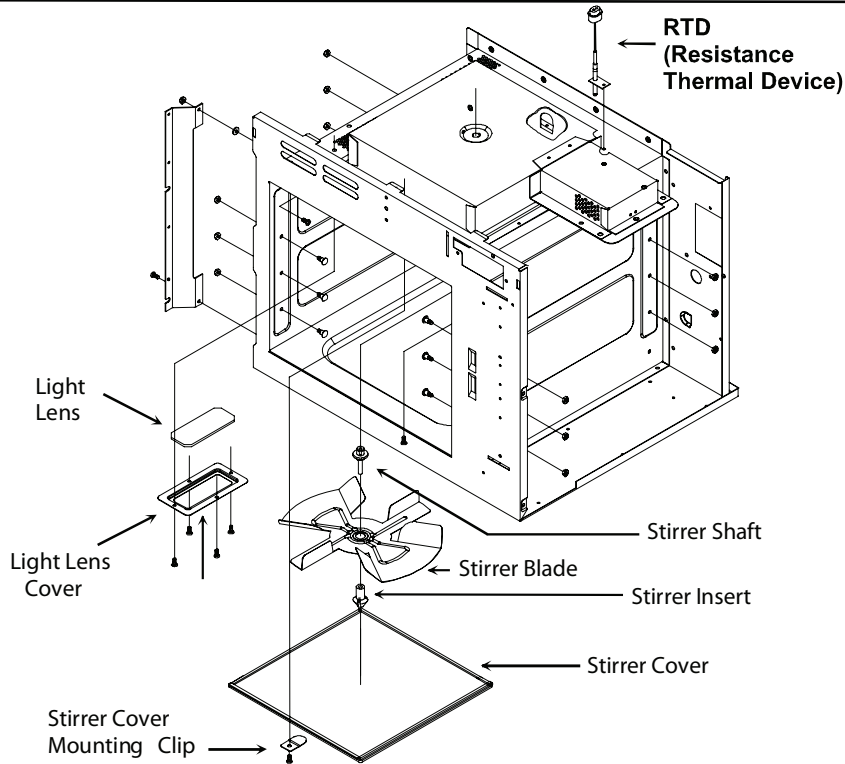

Figure 5  
Stirrer Assembly

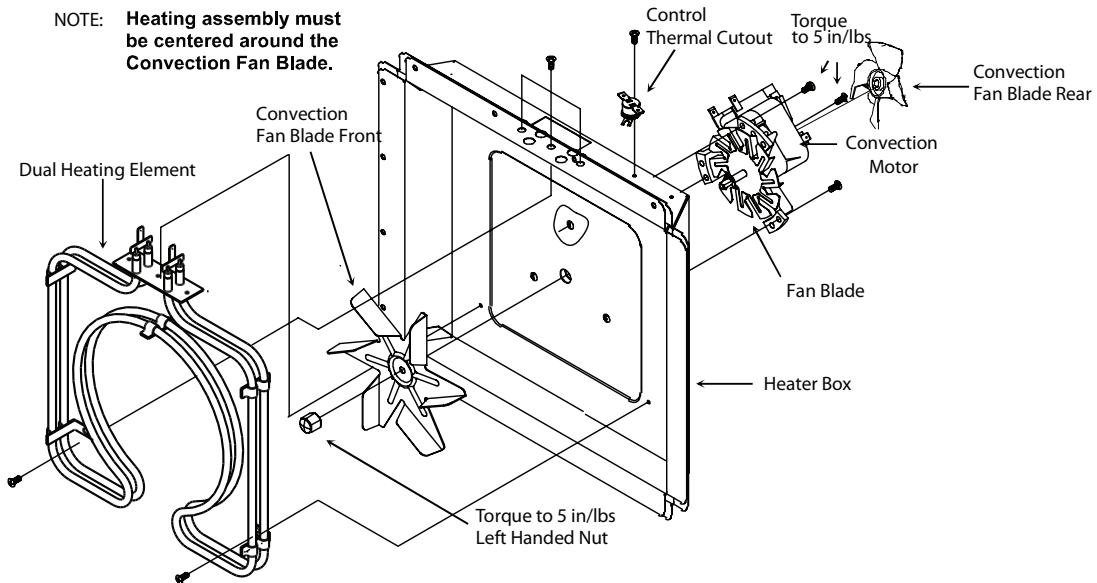

Figure 6  
Heater Assembly

# Oven Performance Test

All Amana and Menumaster microwave oven power outputs are rated using the IEC705 standards. Using the IEC705 test method requires precision measurements and equipment that is not practical to be performed in the field. Using the test shown below will indicate if the oven performance is satisfactory.

## Test equipment required:

- 1000 ml test container and thermometer (ACP Power Test Bpwl part # 12018801).
- Digital watch / watch with a second hand for use on ovens with electromechanical timers.

## Important Notes:

- Low line voltage will cause low temperature rise / power output.
- Ovens must be on a dedicated circuit, properly grounded, and polarized. Other equipment on the same circuit may cause a low temperature rise / power output.
- This test and results are not a true IEC705 test procedures and are only intended to provide servicers with an easy means of determining if the microwave oven cooking output is correct.

## Procedure

**NOTE:** Oven cavity must be cold.

1. Fill the test container to the 1000 ml line with cool tap water.

**NOTE:** Water temperature should be approximately 60°F / 16°C

2. Using the thermometer, stir water for five to ten seconds; measure, and record the temperature (T1).
3. Place test container of water in the center of oven cavity and close door.
4. Place oven in to service mode and select service test pad 3. Magnetron will operate only.
5. Heat the water for a 33-second full power cycle.

**NOTE:** Use a digital watch or a watch with a second hand for ovens with electromechanical timers.

6. At end of the cycle, remove test container. Using the thermometer, stir water for five to ten seconds and record temperature (T2).
7. Subtract the starting water temperature (T1), from the ending water temperature (T2) to obtain the temperature rise ( $\Delta T$ ).
8. If the temperature rise ( $\Delta T$ ) meets or exceeds the minimum, the test is complete. If the temperature rise ( $\Delta T$ ) fails to meet the minimum temperature rise, test the line voltage to verify it is correct. Then repeat steps 1-6 making sure to change the water. If the temperature rise ( $\Delta T$ ) fails to meet the minimum temperature rise again the oven will require service.

**Minimum Temperature Rise at Thirty -Three (33) Seconds Run Time**

$\Delta T$ (°F)	Cooking Power Output	$\Delta T$ (°F)	Cooking Power Output	$\Delta T$ (°C)	Cooking Power Output	$\Delta T$ (°C)	Cooking Power Output
10.....	1000	20 .....	2000	5 .....	1000	11 .....	2000
11.....	1100	21 .....	2100	5.5 .....	1100	11.5 .....	2100
12.....	1200	22 .....	2200	6.5 .....	1200	12 .....	2200
14.....	1400	24 .....	2400	7.5 .....	1400	13 .....	2400
17.....	1700	25 .....	2500	9.5 .....	1700	13.5 .....	2500
18.....	1800	27 .....	2700	10 .....	1800	15 .....	2700
19.....	1900	30 .....	3000	10.5 .....	1900	16.5 .....	3000



# **7** | **ACE14 / MCE14 60 Hz Component Testing Procedures**

# Component Testing Procedures



## WARNING

To avoid risk of electrical shock, personal injury or death; disconnect power to oven and discharge capacitors before following any disassembly procedures.

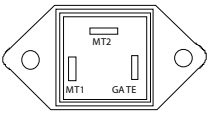
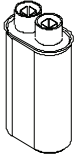
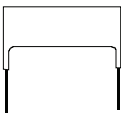
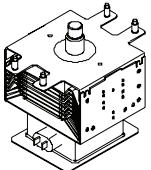
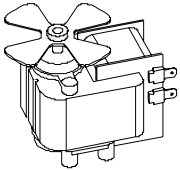
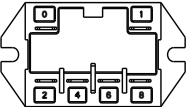
Illustration	Component	Test	Results
	Thermal cutout 31866P01 .....	Disconnect all wires from TCO. Measure resistance across terminals. Control TCO . .....	Open at 300 °F (149 °C) and closed at 257°F (125 °C)
	B5684121 .....	Magnetron TCO.....	Open at 280°F (137°C) and closed at 180°F (82°C)
	Diode	Discharge Capacitor  Remove diode lead from capacitor and connect ohmmeter.  Reverse leads for second test.	Infinite resistance should be measured in one direction and 50KΩ or more in the opposite direction.  NOTE: Ohmmeter must contain a battery of 6 volts minimum.
	Triac	Disconnect wires to triac.  Measure resistance from: MT1 to MT2 .....	Caution - Do not operate oven with wire to terminal MT2 removed.  Infinite Approximately 60 Ω
		MT1 to Gate.....  MT2 to Gate..... All terminals to ground.....	Infinite Infinite
		Voltage check measure voltage from: MT1 to Gate.....	0.8 VAC when energized. If no voltage, check H.V. board and wiring.
	Capacitors – 0.65 µf	Discharge Capacitor  Remove wires from capacitor terminals and connect ohmmeter, set on highest resistance scale to terminals.  Also check between each terminal and capacitor case.	Between Terminals: Meter should momentarily deflect towards zero then return to over 5 M Ω. If no deflection occurs, or if continuous deflection occurs, replace capacitor.  Terminal to Case: Infinite resistance
	Snubber assembly	Disconnect wires to snubber.  Measure resistance across terminals .....	Infinite
	Magnetron	Discharge Capacitor  Remove wires from magnetron and connect ohmmeter to terminals. Also check between each terminal and ground.	Between Terminals: Less than 1 Ω  Each terminal to ground measures Infinite resistance. Note: This test is not conclusive. If oven does not heat and all other components test good replace the magnetron and retest.
	Microwave blower motor	Remove all wires from motor.  Measure resistance across coil.	Approximately 30 Ω
	Power relay	Coil voltage – unit running Terminal 0 to 1..... Coil resistance Terminal 0 to 1..... Relay Contacts 2 - 4..... 6 - 8.....	(line voltage)  21 K Ω (no voltage) (no voltage)

# Component Testing Procedures



## WARNING

To avoid risk of electrical shock, personal injury or death; disconnect power to oven and discharge capacitor before servicing, unless testing requires power.

Illustration	Component	Test	Results
	Transformer	<p><b>Discharge Capacitor</b> Remove all wires from terminals.</p> <p>Measure resistance from: 230 to COM 208 to COM 230 to Ground 208 to Ground Terminal 5 to 6 Terminal 4 to Ground</p>	<p>&lt; 1.5 <math>\Omega</math> &lt; 1.5 <math>\Omega</math> Infinite Infinite &lt; 1 <math>\Omega</math> Approximately 70 <math>\Omega</math></p>
<p>Current Production Starting @ S/N 11071263</p> <p>Door Closed 2 — 3 Secondary 4 — 5 Primary 7 — 8 Monitor</p>	Interlock switch	<p>Disconnect wires to switch.</p> <p>With door open measure resistance from: Terminal 2 to 3 Terminal 4 to 5 Terminal 7 to 8</p> <p>With door closed measure resistance from: Terminal 2 to 3 Terminal 4 to 5 Terminal 7 to 8</p>	<p>Infinite Infinite Infinite</p> <p>Indicates continuity Indicates continuity Indicates continuity</p>
<p>Previous Production Ending @ S/N 11071262</p> <p>Door Closed 2 — 3 Secondary 4 — 5 Primary 7 — 8 Monitor</p>	Interlock switch	<p>Disconnect wires to switch.</p> <p>With door open measure resistance from: Terminal 2 to 3 Terminal 4 to 5 Terminal 7 to 8</p> <p>With door closed measure resistance from: Terminal 2 to 3 Terminal 4 to 5 Terminal 7 to 8</p>	<p>Infinite Infinite Indicates continuity</p> <p>Indicates continuity Indicates continuity Infinite</p>
	Convection blower motor	<p>Remove wires from motor.</p> <p>Measure resistance across terminals A and B.</p>	Approximately 20 $\Omega$
	Heating element assembly	<p>Disconnect wires from terminals.</p> <p>Measure resistance across heating element. Element                      2200 W</p>	Approximately 15 $\Omega$
	Resistance thermal device (RTD)	<p>Temperature</p> <p>0° C (32° F) ..... 24° C (75° F) ..... 177° C (350° F) .....</p>	<p>Resistance</p> <p>1000 <math>\Omega</math> 1091 <math>\Omega</math> 1654 <math>\Omega</math></p>
	Relay board	<p>With power applied remove white and black 4 pin connector from J2 connector.</p> <p>With door closed measure resistance from: Pin 1 to pin 4 on J2 connector.....</p> <p>With door open measure resistance from: Pin 1 to pin 4 on J2 connector.....</p>	<p>Infinite</p> <p>Indicates continuity</p>

# Component Testing Procedures

## ⚠ **WARNING**

To avoid risk of electrical shock, personal injury or death; disconnect power to oven and discharge capacitor before servicing, unless testing requires power.

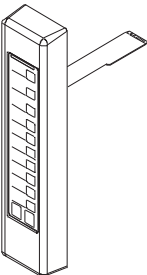
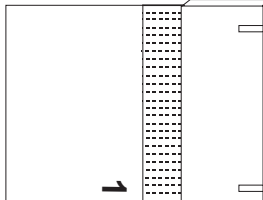
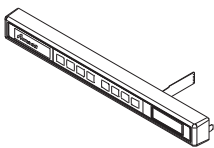
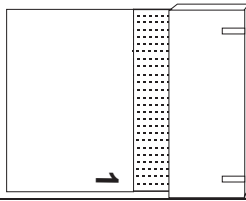
Illustration	Component	Test	Results		
	Side touch panel	Continuity is indicated as 100 $\Omega$ and below. 	<u>Pad</u> 1 2 3 4 5 6 7 8 9 0 Start Stop/Reset	<u>Trace</u> 3 & 5 3 & 6 3 & 7 3 & 8 3 & 9 4 & 5 4 & 6 4 & 7 4 & 8 4 & 9 5 & 6 6 & 9	<u>Measurement</u> Continuity Continuity Continuity Continuity Continuity Continuity Continuity Continuity Continuity Continuity Continuity Continuity
	Top touch panel	Continuity is indicated as 100 $\Omega$ and below. 	<u>Pad</u> Preheat Time Entry Temp Entry Power Level Stage Program Save Hidden Pad	<u>Trace</u> 3 & 4 5 & 7 7 & 8 5 & 8 5 & 9 6 & 7 8 & 9	<u>Measurement</u> Continuity Continuity Continuity Continuity Continuity Continuity Continuity
Wire harness	High voltage board to display module harness	Test continuity of wires.	Indicates continuity		

# Component Testing Procedures



## WARNING

To avoid risk of electrical shock, personal injury or death; disconnect power to oven and discharge capacitor before servicing, unless testing requires power.

H.V. board

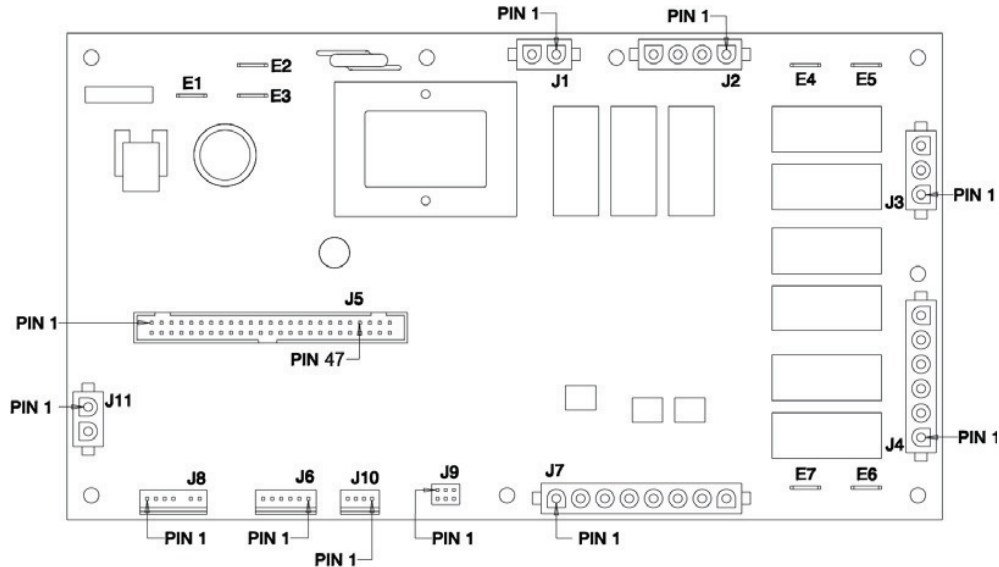

Function	Test Set-Up	Meter Setting	Probe Placement	Results
Input to H.V. board	At H.V. board	Volts	J1 pin 1 (Black wire) & J1 pin 2 (Red wire)	Line voltage
Output to display board	Disconnect J5 connector	Volts	J5 pin 1 & J5 pin 47	7.4 VDC

Function	Test Set-Up	Meter Setting	Probe Placement	Results
Cooling fan	Disconnect J2 connector	Ohms	J1 pin 1 (Black wire) & J2 pin 4	Test mode 5 off – no continuity Test mode 5 on – $< 1 \Omega$
Convection motor	Disconnect J2 connector	Ohms	J1 pin 1 (Black wire) & J2 pin 3	Test mode 4 off – no continuity Test mode 4 on – $< 1 \Omega$
Microwave	Disconnect J4 connector	Ohms	J4 pin 4 & J4 pin 5	Test mode 3 off – no continuity Test mode 3 on – $< 1 \Omega$
Heater	Disconnect J4 connector	Ohms	E6 & J4 pin 1	Test mode 1 off – no continuity Test mode 1 on – $< 1 \Omega$

# 8 | **ACE14 / MCE14** **60 Hz** **Service Test**

# Service Test ACE14 / MCE14

## Accessing Service Mode (Turn Oven Off)

<b>Mode Name</b>	Service Mode
<b>Entry</b>	Pressing Hidden Pad, 1, 3, 5, 7, 9 while in Preheat is OFF
<b>Functional Description</b>	Main Service Mode Menu
<b>Display</b>	
	S e r v i c e M o d e
	6 0 H Z 2 0 8 V

### Pad 1

<b>Mode Name</b>	Service Pad 1
<b>Entry</b>	Pressing Pad 1 while in Service Mode
<b>Functional Description</b>	Calrod #1 and convection fan shall be toggled. When on, it shall run for 62 seconds.
<b>Display</b>	
	C a l r o d : O N
	A m p s : 1 2

### Pad 3

<b>Mode Name</b>	Service Pad 3
<b>Entry</b>	Pressing Pad 3 while in Service Mode
<b>Functional Description</b>	Magnetron #1 shall be toggled. When on, it shall run for 62 seconds.
<b>Display</b>	
	M a g n e t r o n # 1 : O N
	0 0 : 4 5 A m p s : 1 2

# Service Test ACE14 / MCE14

## Pad 4

<b>Mode Name</b>	Service Pad 4
<b>Entry</b>	Pressing Pad 4 while in Service Mode
<b>Functional Description</b>	Convection Fan shall be toggled.
<b>Display</b>	
	C o n v . F a n : O N
	A m p s : 0 3

## Pad 5

<b>Mode Name</b>	Service Pad 5
<b>Entry</b>	Pressing Pad 5 while in Service Mode
<b>Functional Description</b>	Auxiliary Output shall be toggled.
<b>Display</b>	
	A u x . O u t p u t : O N

## Pad 7

<b>Mode Name</b>	Service Pad 7
<b>Entry</b>	Pressing Pad 7 while in Service Mode
<b>Functional Description</b>	Displays Tube Hours stored in EEPROM
<b>Display</b>	
	M a g n e t r o n H o u r S
	0 0 1 7 4 3

# Service Test ACE14 / MCE14

## Pad 8

<b>Mode Name</b>	Service Pad 8
<b>Entry</b>	Pressing Pad 8 while in Service Mode
<b>Functional Description</b>	Displays Door Cycles stored in EEPROM. Will always be a multiple of ten.
<b>Display</b>	
	D o o r C y c l e s
	0 0 2 4 5 3 8 0

## Pad 9

<b>Mode Name</b>	Service Pad 9
<b>Entry</b>	Pressing Pad 9 while in Service Mode
<b>Functional Description</b>	Prompts user to clear service information.
<b>Display</b>	
	P r e s s S T A R T t o
	C l e a r s e r v . i n f o

## Pad 0

<b>Mode Name</b>	Service Pad 0
<b>Entry</b>	Pressing Pad 0 while in Service Mode
<b>Functional Description</b>	Displays offset used when heating cavity.
<b>Display</b>	
	T e m p . O f f s e T
	2 0 ° F

## TEMP Pad

<b>Mode Name</b>	Display Temperature
<b>Entry</b>	Pressing the Temp Pad in Service Mode.
<b>Functional Description</b>	Displays temperature as reported by RTD
<b>Display</b>	
	C a v i t y T e m P
	1 9 4 ° F

# TEST MODES



## WARNING

To avoid risk of electrical shock, personal injury or death; disconnect power to oven and discharge capacitors before following any disassembly procedures.

### Convection Temperature Test

NOTE: It is absolutely necessary to own and use a thermocouple type oven tester to accurately measure oven temperature. No other type of thermometer can take its place.

NOTE: Before testing an oven to check calibration, inspect the RTD for proper mounting.

1. Place one wire rack in center position. Remove any other racks and utensils.
2. Clip thermocouple to the center rack and run lead outside oven door, or wrap thermocouple around rack and have the tip of thermocouple extend upward towards top of cavity approximately 1".
3. Press *PREHEAT ON/OFF* pad.
4. Press *PROGRAM SAVE* pad.
5. Press *TEMP* pad.
6. Enter 450°F.
7. Allow oven to cycle one time.
8. Record high and low peaks from next two cycles.

NOTE: Display does not indicate if heating elements are on or off.

Fahrenheit Example:

	<u>LOW</u>		<u>HIGH</u>	
Cycle 1	440°F		460°F	
Cycle 2	<u>439°F</u>		<u>461°F</u>	
	879°F	+	921°F	= 1800°F
	1800°F / 4 = 450°F average temperature			

Celsius Example:

	<u>LOW</u>		<u>HIGH</u>	
Cycle 1	230°C		240°C	
Cycle 2	<u>230°C</u>		<u>240°C</u>	
	460°C	+	480°C	= 940°C
	940°C / 4 = 235°C average temperature			

If the average temperature is too high or too low the oven temperature offset needs to be calibrated.

### Convection Temperature Calibration

NOTE: It is normal for the average oven temperature to vary from the oven setting by as much as 25°F. Difference will not effect cooking since recipes are written with this difference in mind.

### Calibration

NOTE: Door must be closed and unit must be in STANDBY mode.

1. Press *HIDDEN PAD*.
2. Press pads 1,3,5,7, 9.
3. Press "0" pad.



NOTE: Display will show the current offset setting.

4. Press the "0" pad to change the offset.

Fahrenheit

NOTE: Offset temperature range is +40°F to -40°F and advances in 2 and 3° increments.

Celsius

NOTE: Offset temperature range is +22°C to -22°C and advances in 1 and 2° increments.

5. Press *STOP/RESET* pad to save offset changes.

NOTE: Retest the oven after any offset changes are made.

Fahrenheit Example:

- Oven temperature is set for 450°F
- Average of temperature test is 475°F
- Offset setting must be reduced by 25°F
- If offset is shown as 10°, press the "0" pad until -15 is shown in the display (10 - 25 = -15)

Celsius Example:

- Oven temperature is set for 230°C
- Average of temperature test is 240°C
- Offset setting must be reduced by 10°C
- If offset is shown as 5°, press the "0" pad until -5 is shown in the display (5 - 10 = -5)

# DISPLAY DIAGNOSTICS

**Error Codes: During operation, the display may show the following service codes:**

**Note:** Before scheduling service for any error codes, instruct customer to unplug oven for 1 minute, reconnect power, and re-test. If unit operates properly, no service call is required.

<u>DISPLAY</u>	<u>DESCRIPTION</u>	<u>CORRECTIVE ACTION</u>
Error 1U	Chassis Memory Not Found	-Check EZ Card Harness -Replace EZ Card Board
Error 1F	Chassis Memory Not Programmed	-Unplug Oven and Re-Plug In -Replace H.V. Board
Error 2	Failed H.V. Board	-Replace H.V. Board
Error 3	Failed H.V. Board	-Replace H.V. Board
Error 4	Failed H.V. Board	-Replace H.V. Board -Incorrect H.V. Board Installed in Oven
Error 5	Shorted Touch Panel	<b>Note:</b> If touch panel is pressed for more than 30 seconds, this error code will appear. -Disconnect Oven From Power Supply -Disconnect Side Touch Panel Connector From Display Board. -Reconnect Oven to Power Supply -If "Err5" Reappears After 30 Seconds, Replace Top Touch Panel. -If "Err5" Does Not Reappear After 30 Seconds, Replace Side Touch Panel.
Error 6	Options Scrambled	Replace H.V. Board
Error 7-O	Open RTD	Check RTD and Wiring to H.V. Board
Error 7-S	Shorted RTD	Check RTD and Wiring to H.V. Board
Door Open	Door Interlock Primary Switch	-Verify Latch Mechanism Moves Freely On Door. -Verify J1 Connector On Display Board Is Properly Seated. -Test Interlock Switch Assembly and Perform Door Adjustment If Necessary. -Replace Interlock Switch Assembly.
Error Oven to Hot	Control TCO Open	-Check Fan Blade.  -Check Airflow (Filter).  -Fan Motor not Operating.

# 9 | **ACE14 / MCE14** **60 Hz** **Wiring Diagrams / Schematics**

# Wiring Diagram Sample ACE14 / MCE14

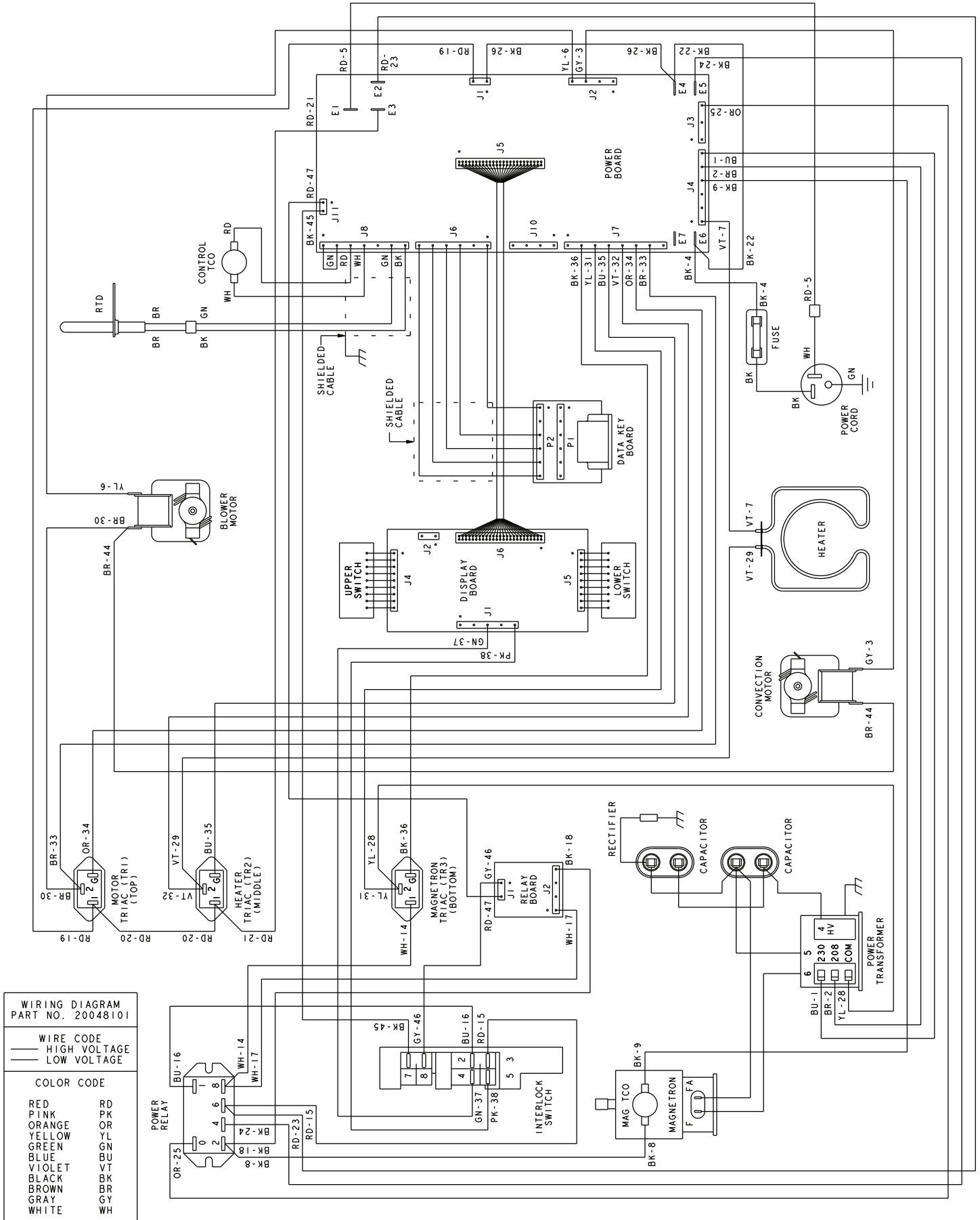

# Schematic Sample ACE14 / MCE14

208/230V 60HZ

SCHEMATIC CONDITION: DOOR OPEN

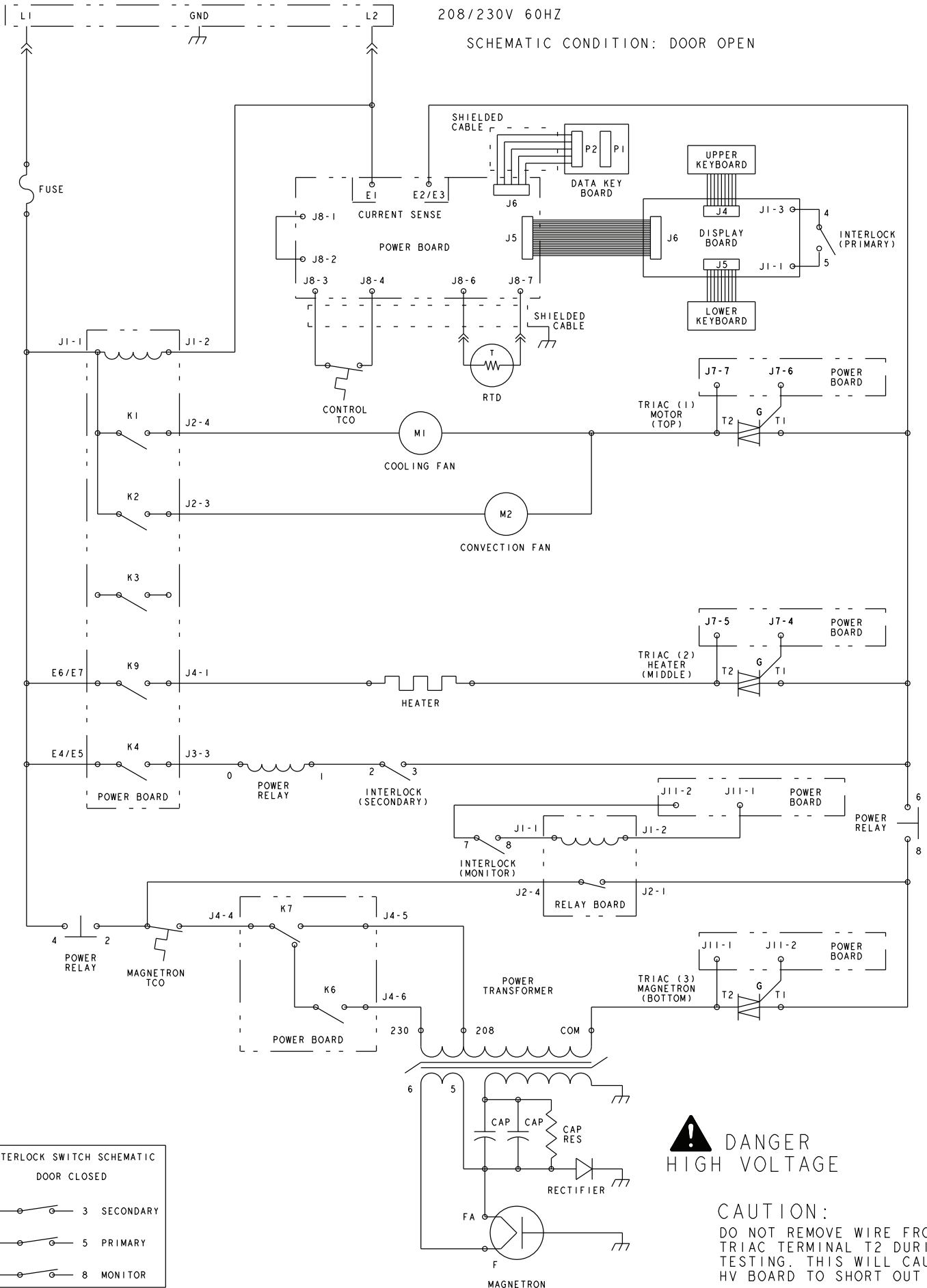

**⚠ DANGER HIGH VOLTAGE**

**CAUTION:**  
DO NOT REMOVE WIRE FROM TRIAC TERMINAL T2 DURING TESTING. THIS WILL CAUSE HV BOARD TO SHORT OUT

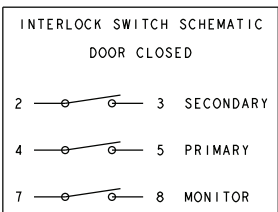

# Notes

