

# Commercial Microwave—Technical Information

## 230V, 50 Hz Models

### JET514C

### P2002712M

- Due to possibility of personal injury or property damage, always contact an authorized technician for servicing or repair of this unit.
- Refer to Service/Training Manual for installation, operating, testing, troubleshooting, and disassembly instruction.



## CAUTION

All safety information must be followed as provided in Service/Training Manual.



## WARNING

To avoid the risk of electrical shock, personal injury or death; disconnect power to oven and discharge capacitor before servicing, unless testing requires power.





Models	JET514C
<b>Power Source</b>	
Voltage AC	230 VAC
Amperage (Single Unit)	16 A
Frequency	50 Hz
Single Phase, 3 wire grounded	YES
Plug	WS-015D or AP-805
<b>Power Output – Microwave</b>	
Nominal microwave energy (IEC705)	1400 Watts
Minimum temperature rise	14°F / 7.5°C
<b>Power Consumption</b>	
Microwave only	500 Watts
Convection only	2700 Watts
Both	2900 Watts
<b>Dimensions</b>	
<b>Cabinet (in / cm)</b>	
Width	19 1/4" 489 mm
Height	18 1/8" 460 mm
Depth	26 5/8 " 676 mm
<b>Oven Interior (in / cm)</b>	
Width	13" 330 mm
Height	10 1/2" 267 mm
Depth	15" 381 mm
<b>Weight</b>	
Crated	112 lbs. 51 kg.
Uncrated	107 lbs. 49 kg.

# Component Testing Procedures

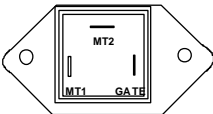
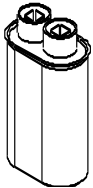

## WARNING

To avoid risk of electrical shock, personal injury or death; disconnect power to oven and discharge capacitor before servicing, unless testing requires power.

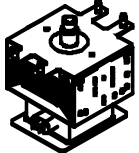
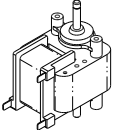
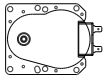
Illustration	Component	Test	Results
	Thermal Cutout	Disconnect all wires from TCO. Measure resistance across terminals. Oven TCO (bottom left rear).....  Cavity TCO (top left).....  Top Cavity TCO (top center).....  Magnetron TCO (2) (on magnetron) .....	Open at 350° F (177° C)  Open at 300° F (149° C) and Closed at 257° F (125° C) Open at 300° F (149° C) and Closed at 257° F (125° C) Open at 300° F (149° C) and Closed at 257° F (125° C)
	Diode	<b>ALWAYS DISCHARGE CAPACITOR !</b>  Remove diode lead from capacitor and connect ohmmeter.  Reverse leads for second test.	Infinite resistance should be measured in one direction and 50KΩ or more in the opposite direction.  <b>NOTE:</b> Ohmmeter must contain a battery of 6 volts minimum.
	Triac (40A)	Disconnect wires to triac.  Measure resistance from: MT1 to MT2..... MT1 to Gate ..... MT2 to Gate ..... All terminals to ground.....	<b>Caution - Do not operate oven with wire to terminal MT2 removed.</b>  Infinite Ω Approximately 60Ω Infinite Ω Infinite Ω
Triac 1 (front) is for Convection Motor Triac 2 (middle) is for Convection Heater Triac 3 (rear) is for Microwave		In cook mode measure voltage from: MT1 to Gate.....  MT1 to MT2.....	0.8 VAC when energized. If no voltage, check H.V. board and wiring. 0VAC
	Capacitor	<b>ALWAYS DISCHARGE CAPACITOR !</b>  Remove wires from capacitor terminals and connect ohmmeter on highest resistance scale or capacitance meter to terminals.  Also check between each terminal and capacitor case.	<b>Capacitance Meter:</b> JET514C = .82μ  <b>Ohm Meter Between Terminals:</b> Meter should momentarily deflect towards zero then return to over 5 MΩ. If no deflection occurs, or if continuous deflection occurs, replace capacitor.  <b>Terminal to Case:</b> Infinite resistance
	Snubber (Triac)	Snubber is comprised of a resistor and capacitor in series. Disconnect wires to Snubber. Measure resistance across terminals.	Using an ohmmeter, a slight deflection may be seen then Infinite.
	Magnetron	<b>Discharge Capacitor!</b>  Remove wires from magnetron and connect ohmmeter to terminals. Also check between each terminal and ground.	Between Terminals: Less than 1Ω  Each terminal to ground measures Infinite resistance. <b>NOTE:</b> This test is not conclusive. If oven does not heat and all other components test good replace the magnetron and retest.
	Blower Motor	Remove all wires from motor.  Measure resistance between: Orange and Yellow terminals .....	Approximately 25Ω
	Stirrer Motor	Remove all wires from terminals. Measure resistance across terminals.....	Approximately 12K Ω

# Component Testing Procedures



## WARNING

To avoid risk of electrical shock, personal injury or death; disconnect power to oven and discharge capacitor before servicing, unless testing requires power.

Illustration	Component	Test	Results
	<b>Transformer</b> 	<b>Discharge Capacitor!</b> Remove all wires from terminals.  Measure resistance from: 230 to COM..... 208 to COM..... 230 to Ground..... 208 to Ground..... Terminal 5 to 6..... Terminal 7 to 8..... Terminal 4 to Ground.....	< 2 Ω < 2 Ω Infinite Ω Infinite Ω < 1 Ω < 1 Ω Approximately 28 Ω
	<b>Interlock switch</b>  Top = Primary 2-3 Middle = Monitor 7-8 Bottom = Secondary 4-5	Disconnect wires to switch.  Door OPEN measure resistance from: Terminal 2 to 3 Terminal 7 to 8 Terminal 4 to 5  Door CLOSED measure resistance from: Terminal 2 to 3 Terminal 7 to 8 Terminal 4 to 5	Open - Infinite Ω Open - Infinite Ω Open - Infinite Ω  Continuity - 0Ω Continuity - 0Ω Continuity - 0Ω
	<b>Convection Blower Motor</b>	Remove all wires from motor.  Measure resistance between:  Orange/Blue and Brown terminals .....	Approximately 25 Ω
	<b>Heater</b> 2700 watt	Disconnect wires from terminals.  Measure resistance across heater	Approximately 19 Ω
	<b>Temp Sensor - RTD</b> (Resistance Thermal Device)	Temperature 0° C (32° F) ..... 24° C (75° F) ..... 177° C (350° F).....	Resistance 1000 Ω 1091 Ω 1654 Ω
	<b>Relay Board</b> (Monitor)	With power applied, disconnect the J2 connector.  With door closed measure resistance from: Pin 1 to pin 4 on J2 connector.....  With door open measure resistance from: Pin 1 to pin 4 on J2 connector.....	Open - Infinite Ω  Continuity - 0Ω

# Component Testing Procedures

## ⚠ WARNING

To avoid risk of electrical shock, personal injury or death; disconnect power to oven and discharge capacitor before servicing, unless testing requires power.

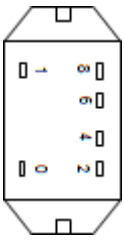
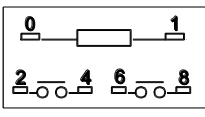
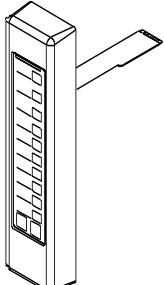
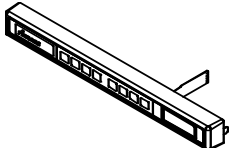
Illustration	Component	Test	Results
	Power Relay	Measure resistance from: Terminal 0 to Terminal 1 (coil) ..... 	Approximately 6 to 7 MΩ (Diode in circuit) <b>Note:</b> If using a digital meter it must contain a battery of 6 volts minimum.  WITHOUT line voltage applied to Terminals 0 and 1: Contacts 2 -4 indicate Open – Infinite Ω Contacts 6 -8 indicate Open – Infinite Ω  WITH line voltage applied to Terminals 0 and 1: Contacts 2 -4 indicate Continuity – 0Ω Contacts 6 -8 indicate Continuity – 0Ω
	Side Touch Panel	Select Time Entry on Top Touch Panel and press each number pad to ensure proper operation.  Inspect for any damage	Each number should operate with equal force. If no response, unplug the Top Touch Panel and test each pad again without selecting Time Entry. If still no response, replace the Side Touch Panel. If Side Touch Panel operates properly with Top Touch Panel disconnected, replace Top Touch Panel.
	Top Touch Panel	Press each pad (including Hidden Pad – see Service Mode) to ensure proper operation.  Inspect for any damage	Each pad should operate with equal force. If no response, unplug the Side Touch Panel and test again. Each pad should respond. If still no response, replace Top Touch Panel.

### Display Board – Connector Locations

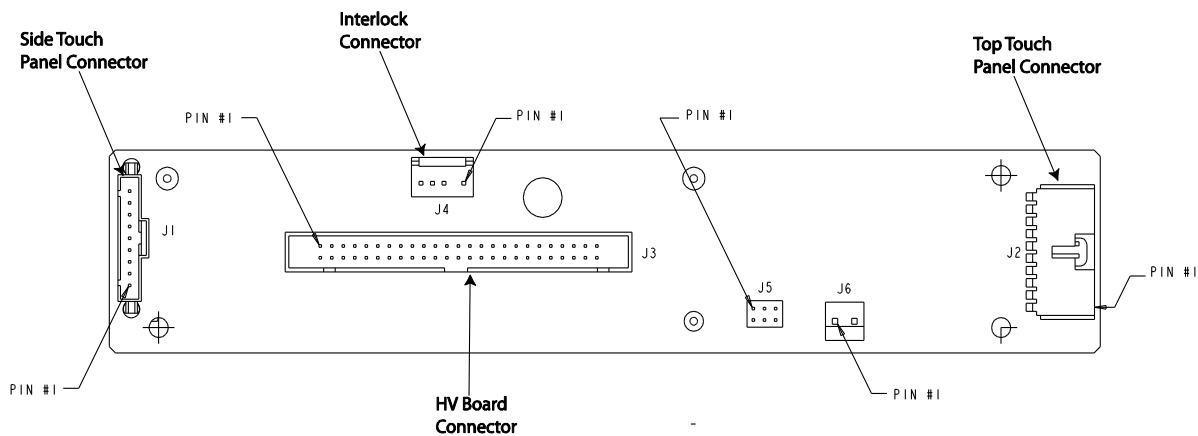

# Component Testing Procedures



## WARNING

To avoid risk of electrical shock, personal injury or death; disconnect power to oven and discharge capacitor before servicing, unless testing requires power.

### H.V. Board – Connector Locations

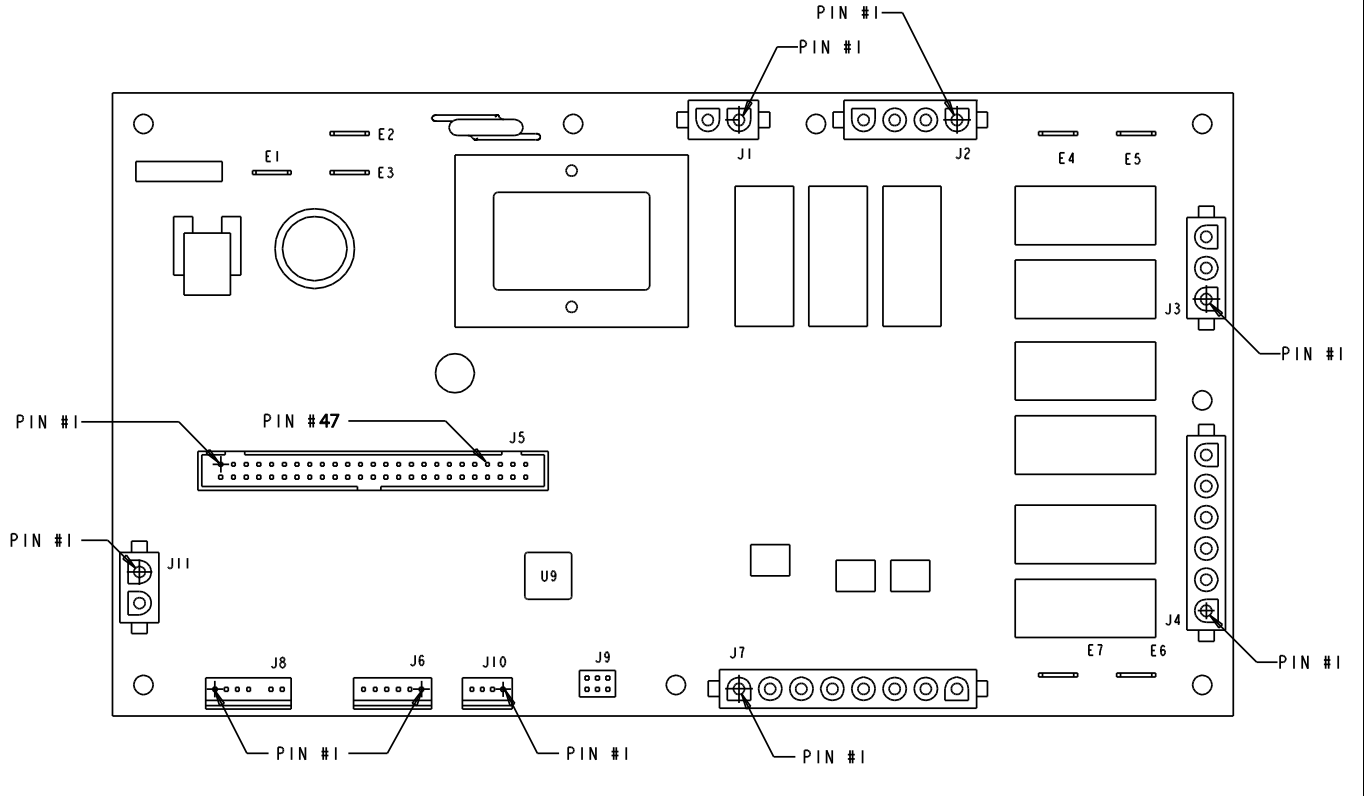

Function	Test Set-Up	Meter Setting	Probe Placement	Results
Input to H.V. Board	At H.V. board	Volts	J1-1 (white) to J1-2 (brown)	Line voltage
Output to Display Board	Disconnect J5 connector	Volts	J5-1 to J5-47	7.4 VDC

Function	Test Set-Up	Meter Setting	Probe Placement	Results
Blower Motor 230v	Door Open	Volts	J2-4 to J3-1	Line Voltage
Convection Motor 230v	Door Open	Volts	J2-4 to J3-1	Line Voltage
Antenna Motor 230v	Door Open	Volts	J2-4 to J3-1	Line Voltage
Microwave	Service Test #3	Volts	J1-2 to J2-3	Line Voltage
Heater	Preheat On or Service Test #1	Volts	J1-2 to J2-2	Line Voltage

# Component Testing Procedures



## WARNING

To avoid risk of electrical shock, personal injury or death; disconnect power to oven and discharge capacitor before servicing, unless testing requires power.

### Power Test

All ACP microwave oven power outputs are rated using the IEC705 standards. Using the IEC705 test method requires precision measurements and equipment that is not practical to be performed in the field. Using the test shown below will indicate if the oven performance is satisfactory.

#### Test equipment required:

- 1000 ml test container and thermometer.

### Procedure

1. Fill the test container to the 1000 ml line with cool tap water as close to 60° F / 16° C as possible.
2. Using the thermometer, stir water for ten seconds; measure, and record the temperature.
3. Place test container of water in the center of oven cavity and close door.
4. Heat the water for a 33-second full power cycle.
5. At end of the cycle, remove test container. Using the thermometer, stir water for ten seconds and record temperature.
6. Subtract the starting water temperature from the ending water temperature to obtain the temperature rise.
7. If the temperature rise meets or exceeds the minimum, the test is complete. If the temperature rise fails to meet the minimum temperature rise, test the line voltage to verify it is correct. Then repeat steps 1-6 making sure to change the water. If the temperature rise fails to meet the minimum temperature rise again the oven will require service.

**Minimum Temperature Rise at Thirty -Three (33) Seconds Run Time**

Rise (°F)	Cooking Power Output	Rise (°C)	Cooking Power Output
14°F .....	1400 .....	7.5°C .....	1400
19°F .....	1900 .....	10.5°C .....	1900

#### Important Notes:

- \* Convection ovens must be at room temperature and set for microwave only (or use Service Test Mode) for best results.
- \* Low line voltage will cause low temperature rise / power output.
- \* Ovens must be on a dedicated circuit, properly grounded, and polarized. Other equipment on the same circuit may cause a low temperature rise / power output.
- \* This test and results are not a true IEC705 test procedure and are only intended to provide servicers with an easy means of determining if the microwave oven cooking output is correct.

# Service Test Mode

 **WARNING**

To avoid risk of electrical shock, personal injury or death; disconnect power to oven and discharge capacitor before servicing, unless testing requires power.



TO ACCESS SERVICE TEST MODE:

- 1) Open and close the door.
- 2) Press and release the Hidden Test Pad, then press 1, 3, 5, 7, & 9 (note: there will be no keypad beep or change in the display).
- 3) Display will show "Service Mode", hz and amount of voltage applied to unit.

TO EXIT SERVICE MODE Press Preheat Stop/Off Pad twice

PAD	RESULT
1	Heater On/Off (NOTE: Amperage will be less than one)
3	Magnetron On/Off (Amperage = 12amps approx.)
4	Convection Fan Motor On/Off (Note: Amperage will be less than one)
5	Cooling Fan On/Off (Blower Motor)
7	Magnetron Hours
8	Door Cycles (Number of door openings)
9	While in this mode, pressing START will reset Magnetron Hours and Door Cycles to 0
0	Temperature Offset. Pressing 0 will change. +40 to -40 degree range
Time Entry	208/230/Automatic Voltage Switching
Temperature	Displays current oven cavity temperature as sensed by RTD

# User Options Menu



## WARNING

To avoid risk of electrical shock, personal injury or death; disconnect power to oven and discharge capacitor before servicing, unless testing requires power.

### Convection Temperature Test

**NOTE:** It is absolutely necessary to own and use a thermocouple type oven tester to accurately measure oven temperature. No other type of thermometer can take its place.

**NOTE:** Before testing an oven to check calibration, inspect the RTD for proper mounting.

1. Place one wire rack in center position. Remove any other racks and utensils.
2. Clip thermocouple to the center rack and run lead outside oven door, or wrap thermocouple around rack and have tip of thermocouple extend upward towards top of cavity approximately 1".
3. Press *PREHEAT ON/OFF* pad.
4. Press *PROGRAM SAVE* pad.
5. Press *TEMP* pad.
6. Enter 475° F (250° C).
7. Allow oven to cycle one time.
8. Record high and low peaks from next two cycles.

**NOTE:** Display **does not** indicate if heating elements are on or off.

#### Fahrenheit Example:

		<u>LOW</u>		<u>HIGH</u>
Cycle 1		465°F		485°F
Cycle 2		464°F		486°F
		929° F	+	971°F = 1900° F
		1900°F / 4 = 475°F average temperature		

#### Celsius Example:

		<u>LOW</u>		<u>HIGH</u>
Cycle 1		240°C		260°C
Cycle 2		240°C		260°C
		480°C	+	520°C = 1000°C
		1000°C / 4 = 250°C average temperature		

If the average temperature is too high or too low the oven temperature offset needs to be calibrated.

### Convection Temperature Calibration

**NOTE:** It is normal for the average oven temperature to vary from the oven setting by as much as 40° F (14° C). Difference will not effect cooking since recipes are written with this difference in mind.

#### Calibration

**NOTE:** Door must be closed.

1. Press *HIDDEN PAD*.
2. Press pads 1,3,5,7, 9.
3. Press "0" pad.



**NOTE:** Display will show the current offset setting.

4. Press the "0" pad to change the offset.

#### Fahrenheit

**NOTE:** Offset temperature range is +40° F to -40° F and advances in 1° increments.

#### Celsius

**NOTE:** Offset temperature range is +22° C to -22° C and advances in 1° and 2° increments.

5. Press *STOP/RESET* pad to save offset changes.

**NOTE:** Retest the oven after any offset changes are made.

#### Fahrenheit Example:

- Oven temperature is set for 450° F
- Average of temperature test is 475° F
- Offset setting must be reduced by 25° F
- If offset is shown as 10°, press the "0" pad until -15 is shown in the display (10 – 25 = -15).

#### Celsius Example:

- Oven temperature is set for 230° C
- Average of temperature test is 240° C
- Offset setting must be reduced by 10° C
- If offset is shown as 5°, press the "0" pad until -5 is shown in the display (5– 10= -5).

# Test Modes



To avoid risk of electrical shock, personal injury, or death, disconnect power to oven and discharge capacitor before servicing, unless testing requires it.

**Error Codes: During operation, the display may show the following service codes:**

**Note:** Before scheduling service for any error codes, instruct customer to unplug oven for 1 minute, reconnect power, and re-test. If unit operates properly, no service call is required.

<u>DISPLAY</u>	<u>DESCRIPTION</u>	<u>CORRECTIVE ACTION</u>
Error Code: 2	Shorted Touch Panel or Failed H.V. Board	-Replace H.V. Board -Replace Touch Panel
Error Code: 3	Failed H.V. Board	-Replace H.V. Board -Replace Touch Panel
Error Code: 4	Failed H.V. Board	-Replace H.V. Board -Incorrect H.V. Board Installed in Oven
Error Code: 5	Shorted Touch Panel	<b>Note:</b> If touch panel is pressed for more than 30 seconds, this error code will appear. -Disconnect Oven From Power Supply -Disconnect Side Touch Panel Connector From Display Board. -Reconnect Oven to Power Supply -If "Error Code: 5" Reappears After 30 Seconds, Replace Top Touch Panel. -If "Error Code: 5" Does Not Reappear After 30 Seconds, Replace Side Touch Panel.
Error Code: 6	Options Scrambled	Replace H.V. Board
Error Code: 7-O	Open RTD	Check RTD and Wiring to H.V. Board
Error Code: 7-S	Shorted RTD	Check RTD and Wiring to H.V. Board
Door Open	Door Interlock Primary Switch	-Verify Latch Mechanism Moves Freely On Door. -Verify J1 Connector On Display Board Is Properly Seated. -Test Interlock Switch Assembly and Perform Door Adjustment If Necessary. -Replace Interlock Switch Assembly.

# Wiring Diagram and Schematic



**WARNING**

To avoid risk of electrical shock, personal injury or death; disconnect power to oven and discharge capacitor before servicing, unless testing requires power.

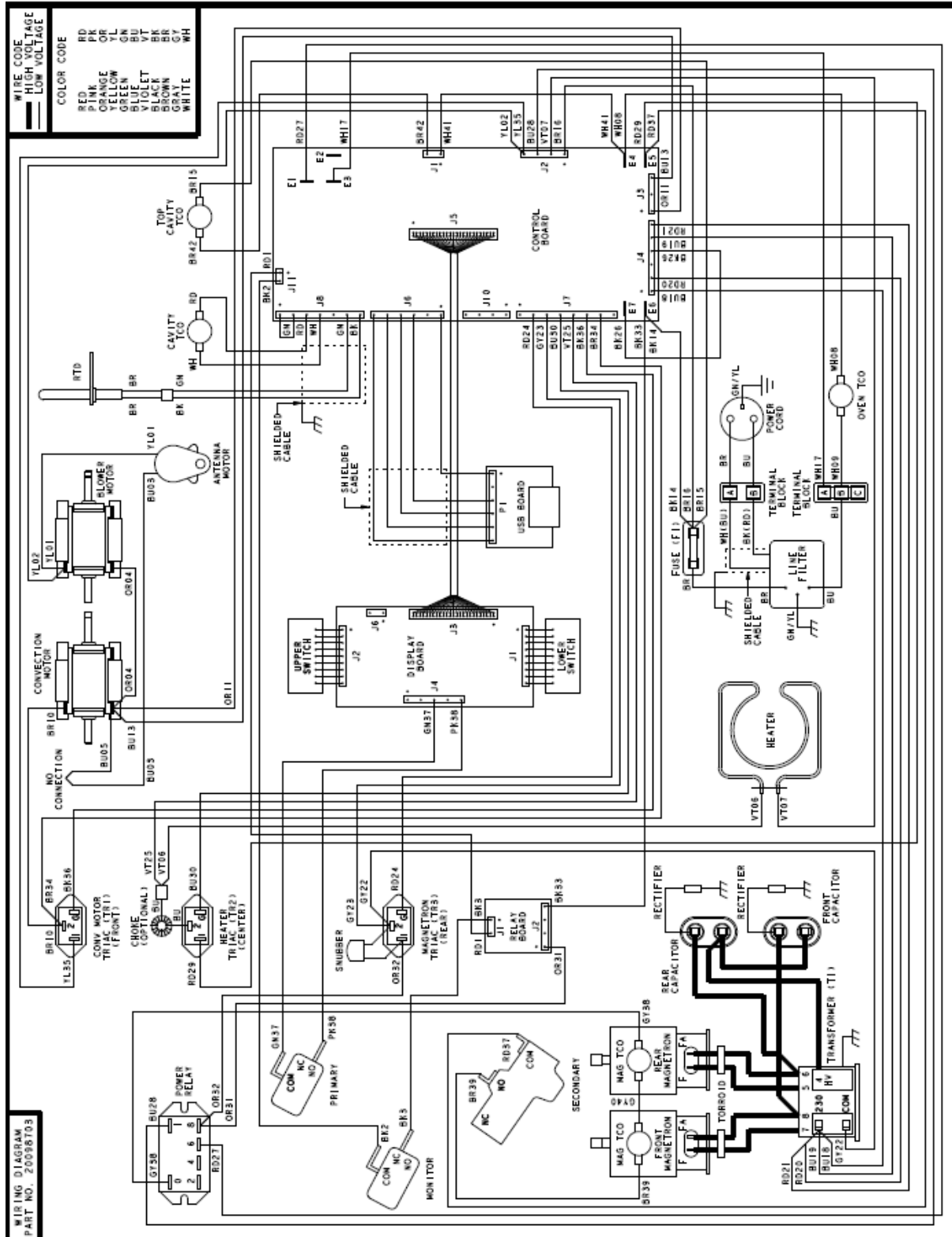

# Wiring Diagram and Schematic

**⚠ WARNING**

To avoid risk of electrical shock, personal injury or death; disconnect power to oven and discharge capacitor before servicing, unless testing requires power.

