

International Commercial Microwave—Technical Information

230 V, 50 Hz Models

DS1400E
CDS1400E

P2001904M
P2001907M

UCA1400
CCA1400

P2001906M
P2001908M

- Due to possibility of personal injury or property damage, always contact an authorized technician for servicing or repair of this unit.
- Refer to Service Manual for detailed installation, operating, testing, troubleshooting, and disassembly instructions.



CAUTION

All safety information must be followed as provided in Service Manual



WARNING





To avoid risk of electrical shock, personal injury, or death, disconnect power to oven and discharge capacitor before servicing, unless testing requires power.

Models	DS1400E	UCA1400	CDS1400E	CCA1400
Power Source				
Voltage AC	230 VAC	230 VAC	230 VAC	230 VAC
Amperage (single unit)	16 A	13 A	16A	13A
Frequency	50 Hz	50 Hz	50 Hz	50 Hz
Single phase, 3 wire earthed	X	X	X	X
Plug	CEE 7/7 Schuko	BS1363A	WS-015D	WS-015D
Power Output				
Nominal microwave energy (IEC705)	1400 Watts	1400 Watts	1400 Watts	1400 Watts
Minimum temperature rise (ΔT)	10°F/ 5°C	10°F/ 5°C	10°F/ 5°C	10°F/ 5°C
Operating frequency	2450 MHz	2450 MHz	2450 MHz	2450 MHz
Power Consumption				
Microwave only	2800 Watts	2800 Watts	2800 Watts	2800 Watts
Convection only	2700 Watts	2700 Watts	2700 Watts	2700 Watts
Combination	3400 Watts	3000 Watts	3400 Watts	3000 Watts
Dimensions				
Cabinet				
Width	49 cm (19 1/4")	49 cm (19 1/4")	49 cm (19 1/4")	49 cm (19 1/4")
Height	46 cm (18 1/4")	46 cm (18 1/4")	46 cm (18 1/4")	46 cm (18 1/4")
Depth	67 cm (26 1/4")	67 cm (26 1/4")	67 cm (26 1/4")	67 cm (26 1/4")
Oven Interior				
Width	33 cm (13")	33 cm (13")	33 cm (13")	33 cm (13")
Height	27 cm (10 1/2")	27 cm (10 1/2")	27 cm (10 1/2")	27 cm (10 1/2")
Depth	38 cm (15")	38 cm (15")	38 cm (15")	38 cm (15")
Weight				
Crated	46 kg (102 lbs.)	46 kg (102 lbs.)	46 kg (102 lbs.)	46 kg (102 lbs.)
Uncrated	43 kg (95 lbs.)	43 kg (95 lbs.)	43 kg (95 lbs.)	43 kg (95 lbs.)

Component Testing Procedures

! WARNING

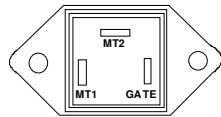
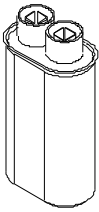

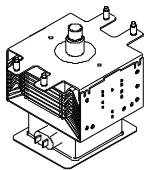
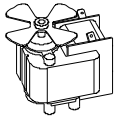
To avoid risk of electrical shock, personal injury, or death, disconnect power to oven and discharge capacitor before servicing, unless testing requires power.

Illustration	Component	Testing	Results
	Thermal Cutout	Disconnect all wires from TCO. Measure resistance across terminals. Oven TCO..... Limiter TCO..... Magnetron TCO	Open at 149° C (300° F). Open at 52° C (125° F) and closed at 71° C (160° F). Open at 137° C (280° F) and closed at 82° C (180° F).
	Diode Assembly	Discharge Capacitors Remove diode lead from capacitor and connect ohmmeter. Reverse leads for second test.	Infinite resistance should be measured in one direction and 50KΩ or more in the opposite direction. NOTE: Analog meter must contain a battery of 6 volts minimum.
	Triac	Disconnect wires to triac. Measure resistance from: MT1 to MT2 MT1 to Gate..... MT2 to Gate..... All terminals to ground	Caution - Do not operate oven with wire to terminal MT2 removed. Infinite. Approximately 60 Ω or more. Infinite. Infinite.
	Capacitor	Discharge Capacitors Remove wires from capacitor terminals and connect ohmmeter, set on highest resistance scale to terminals. Also check between each terminal and capacitor case.	Between Terminals: Meter should momentarily deflect towards zero then return to over 5 MΩ. If no deflection occurs, or if continuous deflection occurs, replace capacitor. Terminal to Case: Infinite resistance.
	Snubber Assembly	Disconnect wires to snubber. Measure resistance across terminals.....	Infinite.
	Magnetron	Discharge Capacitors Remove wires from magnetron and connect ohmmeter to terminals. Also check between each terminal and ground.	Between Terminals: Less than 1 Ω. Each terminal to ground measures Infinite resistance. NOTE: This test is not conclusive. If oven does not heat and all other components test good replace the magnetron and retest.
	Blower Motor	Remove all wires from motor. Measure resistance across coil.....	Approximately 30 Ω.
	Power relay	Coil voltage –unit running Terminal 0 to 1..... Coil resistance.....	(line voltage) 21 K Ω

Component Testing Procedures

⚠ WARNING

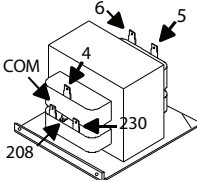
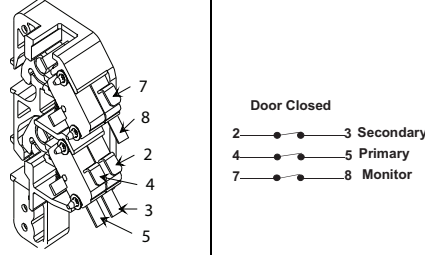
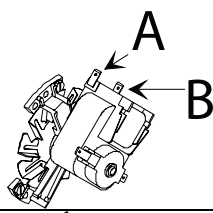
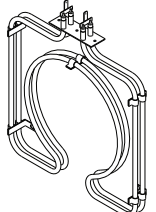
To avoid risk of electrical shock, personal injury, or death, disconnect power to oven and discharge capacitor before servicing, unless testing requires power.

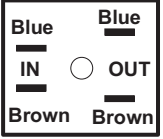
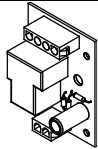
Illustration	Component	Testing	Results
	Transformer	Discharge Capacitor Remove all wires from terminals, and measure resistance from: 230 to Common..... 208 to Common..... 230 to Ground Terminal 5 to 6..... Terminal 4 to Ground	1 Ω. <1 Ω. Infinite. <1 Ω Approximately 60 -70 Ω.
	Interlock switch assembly	Disconnect wires to switch. With door open measure resistance from: Terminal 2 to 3 Terminal 4 to 5 Terminal 7 to 8 With door closed measure resistance from: Terminal 2 to 3 Terminal 4 to 5 Terminal 7 to 8	Infinite. Infinite. Infinite Continuity. Continuity. Continuity
	Convection blower motor	Remove wires from motor. Measure resistance across terminals A and B.....	Approximately 20 Ω
	Heating element assembly	Disconnect wires from terminals. Measure resistance across heating element. Front element 1200 W Rear element 1500 W	Approximately 19 Ω
	Resistance thermal device (RTD)	Temperature 0°C (32 °F)..... 24°C (75 °F)..... 177°C (350 °F).....	Resistance 1000 Ω 1091 Ω 1654 Ω
	Line filter	Disconnect wire from terminals. Measure resistance of the following terminals. Blue to Blue..... Brown to Brown.....	<1 Ω <1 Ω
	Relay board	With power applied remove white and black 4 pin connector from J2 connector. With door closed measure resistance from: Pin 1 to pin 4 on J2 connector..... With door open measure resistance from: Pin 1 to pin 4 on J2 connector.....	Infinite Indicates continuity

Component Testing Procedures

⚠ **WARNING**

To avoid risk of electrical shock, personal injury, or death, disconnect power to oven and discharge capacitor before servicing, unless testing requires power.

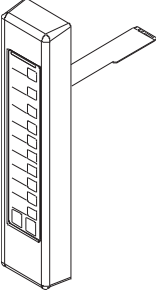
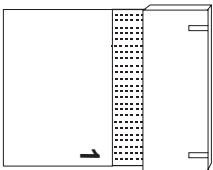
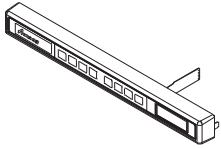
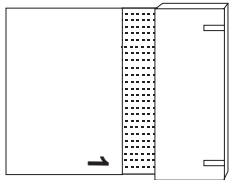
Illustration	Component	Testing	Results		
			Pad	Trace	Measurement
	Side touch panel	Continuity is indicated as 100 Ω and below. 	Pad 1 2 3 4 5 6 7 8 9 0 Start Stop/Reset	Trace 3 & 5 3 & 6 3 & 7 3 & 8 3 & 9 4 & 5 4 & 6 4 & 7 4 & 8 4 & 9 5 & 6 6 & 9	Measurement Continuity Continuity Continuity Continuity Continuity Continuity Continuity Continuity Continuity Continuity Continuity Continuity
	Top touch panel	Continuity is indicated as 100 Ω and below. 	Pad Preheat Time Entry Temp Entry Power Level Stage Program Save Hidden Pad	Trace 3 & 4 5 & 7 7 & 8 5 & 8 5 & 9 6 & 7 8 & 9	Measurement Continuity Continuity Continuity Continuity Continuity Continuity Continuity
Wire Harness	High voltage board to display module harness	Test continuity of wires	Continuity.		

Component Testing Procedures



WARNING

To avoid risk of electrical shock, personal injury, or death, disconnect power to oven and discharge capacitor before servicing, unless testing requires power.

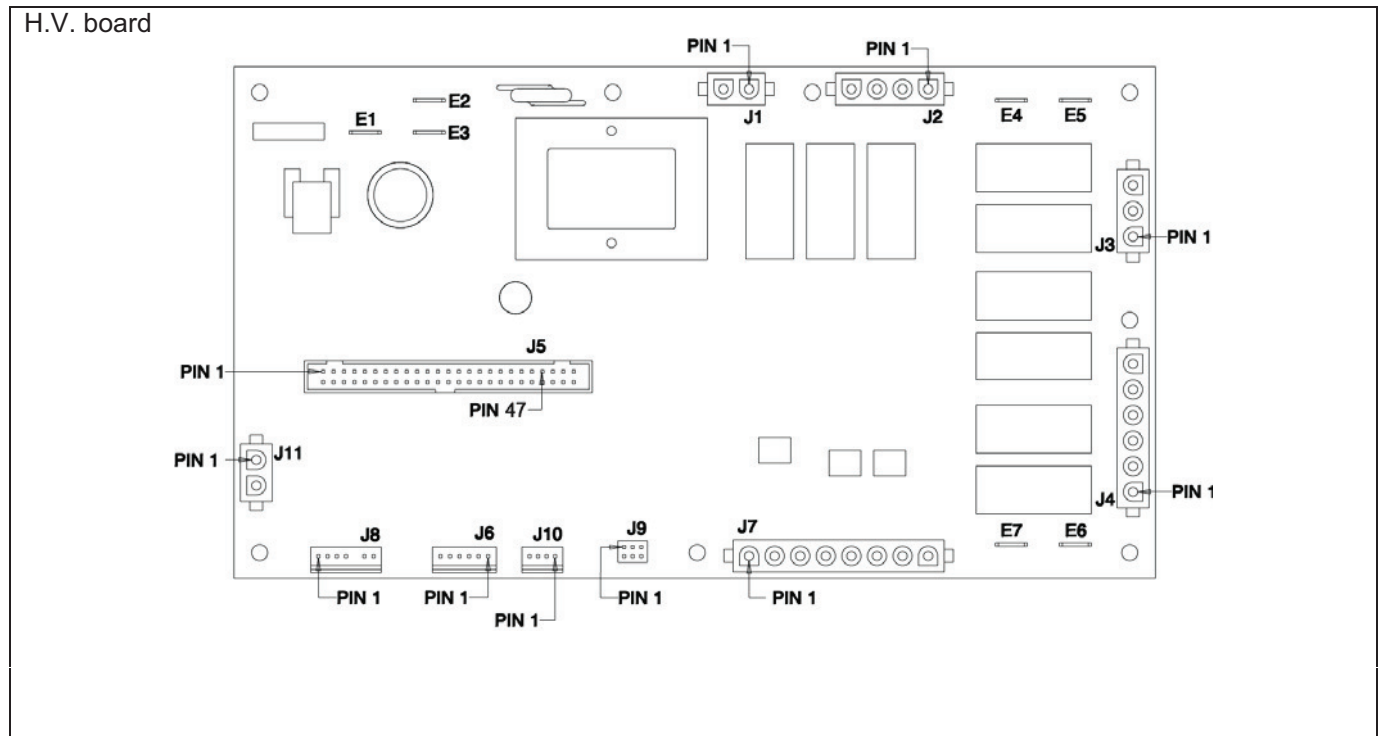

Function	Test Set-Up	Meter Setting	Probe Placement	Results
Input to H.V. board	At H.V. board	Volts	J1 pin 1 (Black wire) & J1 pin 2 (Red wire)	Line voltage
Output to display board	Disconnect J5 connector	Volts	J5 pin 1 & J5 pin 47	7.4 VDC

Function	Test Set-Up	Meter Setting	Probe Placement	Results
Cooling fan	Disconnect J2 connector	Ohms	J1 pin 1 (Black wire) & J2 pin 4	Test mode 5 off – no continuity Test mode 5 on – $< 1 \Omega$
Convection motor	Disconnect J2 connector	Ohms	J1 pin 1 (Black wire) & J2 pin 3	Test mode 4 off – no continuity Test mode 4 on – $< 1 \Omega$
Microwave	Disconnect J4 connector	Ohms	J4 pin 4 & J4 pin 5	Test mode 3 off – no continuity Test mode 3 on – $< 1 \Omega$
Heater	Disconnect J4 connector	Ohms	E6 & J4 pin 1	Test mode 1 off – no continuity Test mode 1 on – $< 1 \Omega$

Power Test



WARNING

To avoid risk of electrical shock, personal injury, or death, disconnect power to oven and discharge capacitor before servicing, unless testing requires power.

Power Test

All Amana and Menumaster microwave oven power outputs are rated using the IEC705 standards. Using the IEC705 test method requires precision measurements and equipment that is not practical to be performed in the field. Using the test shown below will indicate if the oven performance is satisfactory.

Test equipment required:

- 1000 ml test container and thermometer (Part # 12018801) and thermometer.
- Digital watch / watch with a second hand for use on ovens with electromechanical timers.

Important Notes:

- Low line voltage will cause low temperature rise / power output.
- Ovens must be on a dedicated circuit, properly grounded, and polarized. Other equipment on the same circuit may cause a low temperature rise / power output.
- This test and results are not a true IEC705 test procedure and are only intended to provide servicers with an easy means of determining if the microwave oven cooking output is correct.

Procedure

1. Fill the test container to the 1000 ml line with cool tap water.

NOTE: Water temperature should be approximately 60° F / 16° C.

2. Using the thermometer, stir water for five to ten seconds; measure, and record the temperature (T1).
3. Place test container of water in the center of oven cavity and close door.
4. Heat the water for a 33-second full power cycle.

NOTE: Use a digital watch or a watch with a second hand for ovens with electromechanical timers.

1. At end of the cycle, remove test container. Using the thermometer, stir water for five to ten seconds and record temperature (T2).
2. Subtract the starting water temperature (T1), from the ending water temperature (T2) to obtain the temperature rise (ΔT).
3. If the temperature rise (ΔT) meets or exceeds the minimum, the test is complete. If the temperature rise (ΔT) fails to meet the minimum temperature rise, test the line voltage to verify it is correct. Then repeat steps 1-6 making sure to change the water. If the temperature rise (ΔT) fails to meet the minimum temperature rise again the oven will require service.

Minimum Temperature Rise at Thirty-Three (33) Seconds Run Time

ΔT (°F)	Cooking Power Output	ΔT (°C)	Cooking Power Output
14 °F.....	1400	7.5 °C.....	1400

Service Mode



WARNING

To avoid risk of electrical shock, personal injury, or death, disconnect power to oven and discharge capacitor before servicing, unless testing requires power.

Accessing Service Mode

Mode Name	Service Mode																																								
Entry	Pressing Hidden Pad, 1, 3, 5, 7, 9 while in Preheat is OFF																																								
Functional Description	Main Service Mode Menu																																								
Display	<table border="1"> <tr> <td></td><td></td><td></td><td></td><td>S</td><td>e</td><td>r</td><td>v</td><td>i</td><td>c</td><td>e</td><td></td><td>M</td><td>o</td><td>d</td><td>e</td><td></td><td></td><td></td><td></td> </tr> <tr> <td></td><td></td><td></td><td></td><td>6</td><td>0</td><td></td><td></td><td>H</td><td>Z</td><td></td><td></td><td>2</td><td>0</td><td>8</td><td></td><td>V</td><td></td><td></td><td></td> </tr> </table>					S	e	r	v	i	c	e		M	o	d	e									6	0			H	Z			2	0	8		V			
				S	e	r	v	i	c	e		M	o	d	e																										
				6	0			H	Z			2	0	8		V																									

Pad 1

Mode Name	Service Pad 1																																								
Entry	Pressing Pad 1 while in Service Mode																																								
Functional Description	Calrod #1 and convection fan shall be toggled. When on, it shall run for 62 seconds.																																								
Display	<table border="1"> <tr> <td></td><td></td><td></td><td></td><td></td><td></td><td>C</td><td>a</td><td>l</td><td>r</td><td>o</td><td>d</td><td>:</td><td></td><td></td><td></td><td></td><td></td><td>O</td><td>N</td> </tr> <tr> <td></td><td></td><td></td><td></td><td></td><td></td><td></td><td></td><td></td><td></td><td></td><td>A</td><td>m</td><td>p</td><td>s</td><td>:</td><td></td><td></td><td>1</td><td>2</td> </tr> </table>							C	a	l	r	o	d	:						O	N												A	m	p	s	:			1	2
						C	a	l	r	o	d	:						O	N																						
											A	m	p	s	:			1	2																						

Pad 3

Mode Name	Service Pad 3																																								
Entry	Pressing Pad 3 while in Service Mode																																								
Functional Description	Magnetron #1 shall be toggled. When on, it shall run for 62 seconds.																																								
Display	<table border="1"> <tr> <td></td><td></td><td>M</td><td>a</td><td>g</td><td>n</td><td>e</td><td>t</td><td>r</td><td>o</td><td>n</td><td></td><td>#</td><td>1</td><td>:</td><td></td><td></td><td></td><td>O</td><td>N</td> </tr> <tr> <td></td><td></td><td>0</td><td>0</td><td>:</td><td>4</td><td>5</td><td></td><td></td><td></td><td></td><td>A</td><td>m</td><td>p</td><td>s</td><td>:</td><td></td><td></td><td>1</td><td>2</td> </tr> </table>			M	a	g	n	e	t	r	o	n		#	1	:				O	N			0	0	:	4	5					A	m	p	s	:			1	2
		M	a	g	n	e	t	r	o	n		#	1	:				O	N																						
		0	0	:	4	5					A	m	p	s	:			1	2																						

Service Mode



WARNING

To avoid risk of electrical shock, personal injury, or death, disconnect power to oven and discharge capacitor before servicing, unless testing requires power.

Pad 4

Mode Name	Service Pad 4
Entry	Pressing Pad 4 while in Service Mode
Functional Description	Convection Fan shall be toggled.
Display	
	C o n v . F a n : O N
	A m p s : 0 3

Pad 5

Mode Name	Service Pad 5
Entry	Pressing Pad 5 while in Service Mode
Functional Description	Auxiliary Output shall be toggled.
Display	
	A u x . O u t p u t : O N

Pad 7

Mode Name	Service Pad 7
Entry	Pressing Pad 7 while in Service Mode
Functional Description	Displays Tube Hours stored in EEPROM
Display	
	M a g n e t r o n H o u r S
	0 0 1 7 4 3

Service Mode



WARNING

To avoid risk of electrical shock, personal injury, or death, disconnect power to oven and discharge capacitor before servicing, unless testing requires power.

Pad 8

Mode Name	Service Pad 8
Entry	Pressing Pad 8 while in Service Mode
Functional Description	Displays Door Cycles stored in EEPROM. Will always be a multiple of ten.
Display	
	D o o r C y c l e s
	0 0 2 4 5 3 8 0

Pad 9

Mode Name	Service Pad 9
Entry	Pressing Pad 9 while in Service Mode
Functional Description	Prompts user to clear service information.
Display	
	P r e s s S T A R T t o
	C l e a r s e r v . i n f o

Pad 0

Mode Name	Service Pad 0
Entry	Pressing Pad 0 while in Service Mode
Functional Description	Displays offset used when heating cavity.
Display	
	T e m p . O f f s e T
	2 0 ° F

TEMP Pad

Mode Name	Display Temperature
Entry	Pressing the Temp Pad in Service Mode.
Functional Description	Displays temperature as reported by RTD
Display	
	C a v i t y T e m P
	3 8 2 ° F

Test Modes



WARNING

To avoid risk of electrical shock, personal injury, or death, disconnect power to oven and discharge capacitor before servicing, unless testing requires power.

Convection Temperature Test

NOTE: It is absolutely necessary to own and use a thermocouple type oven tester to accurately measure oven temperature. No other type of thermometer can take its place.

NOTE: Before testing an oven to check calibration, inspect the RTD for proper mounting.

1. Place one wire rack in center position. Remove any other racks and utensils.
2. Clip thermocouple to the center rack and run lead outside oven door, or wrap thermocouple around rack and have tip of thermocouple extend upward towards top of cavity approximately 1".
3. Press *PREHEAT ON/OFF* pad.
4. Press *PROGRAM SAVE* pad.
5. Press *TEMP* pad.
6. Enter 230° C (450° F).
7. Allow oven to cycle one time.
8. Record high and low peaks from next two cycles.

NOTE: Display **does not** indicate if heating elements are on or off.

Fahrenheit Example:

		<u>LOW</u>		<u>HIGH</u>
Cycle	1	440°F		460°F
Cycle	2	<u>439°F</u>		<u>461°F</u>
		879° F	+	921°F = 1800° F
1800°F / 4 = 450°F average temperature				

Celsius Example:

		<u>LOW</u>		<u>HIGH</u>
Cycle	1	230°C		240°C
Cycle	2	<u>230°C</u>		<u>240°C</u>
		450°C	+	480°C = 930°C
930°C / 4 = 230°C average temperature				

If the average temperature is too high or too low the oven temperature offset needs to be calibrated.

Convection Temperature Calibration

NOTE: It is normal for the average oven temperature to vary from the oven setting by as much as 25° F (14° C). Difference will not effect cooking since recipes are written with this difference in mind.

Calibration

NOTE: Door must be closed.

1. Press *HIDDEN PAD*.
2. Press pads 1,3,5,7, 9.
3. Press "0" pad.



NOTE: Display will show the current offset setting.

4. Press the "0" pad to change the offset.

Fahrenheit

NOTE: Offset temperature range is +40° F to -40° F and advances in 2° and 3° increments.

Celsius

NOTE: Offset temperature range is +22° C to -22° C and advances in 1° and 2° increments.

5. Press *STOP/RESET* pad to save offset changes.

NOTE: Retest the oven after any offset changes are made.

Fahrenheit Example:

- Oven temperature is set for 450° F
- Average of temperature test is 475° F
- Offset setting must be reduced by 25° F
- If offset is shown as 10°, press the "0" pad until -15 is shown in the display (10 – 25 = -15).

Celsius Example:

- Oven temperature is set for 230° C
- Average of temperature test is 240° C
- Offset setting must be reduced by 10° C
- If offset is shown as 5°, press the "0" pad until -5 is shown in the display (5– 10= -5).

Display Diagnostics



WARNING

To avoid risk of electrical shock, personal injury, or death, disconnect power to oven and discharge capacitor before servicing, unless testing requires power.

Error Codes: During operation, the display may show the following service codes:

Note: Before scheduling service for any error codes, instruct customer to unplug oven for 1 minute, reconnect power, and re-test. If unit operates properly, no service call is required.

<u>DISPLAY</u>	<u>DESCRIPTION</u>	<u>CORRECTIVE ACTION</u>
Error 1U	Chassis Memory Not Found	-Check EZ Card Harness -Replace EZ Card Board
Error 1F	Chassis Memory Not Programmed	-Unplug Oven and Re-Plug In -Replace H.V. Board
Error 2	Failed H.V. Board	-Replace H.V. Board -Replace Touch Panel
Error 3	Failed H.V. Board	-Replace H.V. Board -Replace Touch Panel
Error 4	Failed H.V. Board	-Replace H.V. Board -Incorrect H.V. Board Installed in Oven
Error 5	Shorted Touch Panel	Note: If touch panel is pressed for more than 30 seconds, this error code will appear. -Disconnect Oven From Power Supply -Disconnect Side Touch Panel Connector From Display Board. -Reconnect Oven to Power Supply -If "Err5" Reappears After 30 Seconds, Replace Top Touch Panel. -If "Err5" Does Not Reappear After 30 Seconds, Replace Side Touch Panel.
Error 6	Options Scrambled	Replace H.V. Board
Error 7-O	Open RTD	Check RTD and Wiring to H.V. Board
Error 7-S	Shorted RTD	Check RTD and Wiring to H.V. Board
Door Open	Door Interlock Primary Switch	-Verify Latch Mechanism Moves Freely On Door. -Verify J1 Connector On Display Board Is Properly Seated. -Test Interlock Switch Assembly and Perform Door Adjustment If Necessary. -Replace Interlock Switch Assembly.
Error Oven to Hot	Control TCO Open	-Check Fan Blade. -Check Airflow. -Fan Motor not Operating.

Wiring Diagram



WARNING

To avoid risk of electrical shock, personal injury, or death, disconnect power to oven and discharge capacitor before servicing, unless testing requires power.

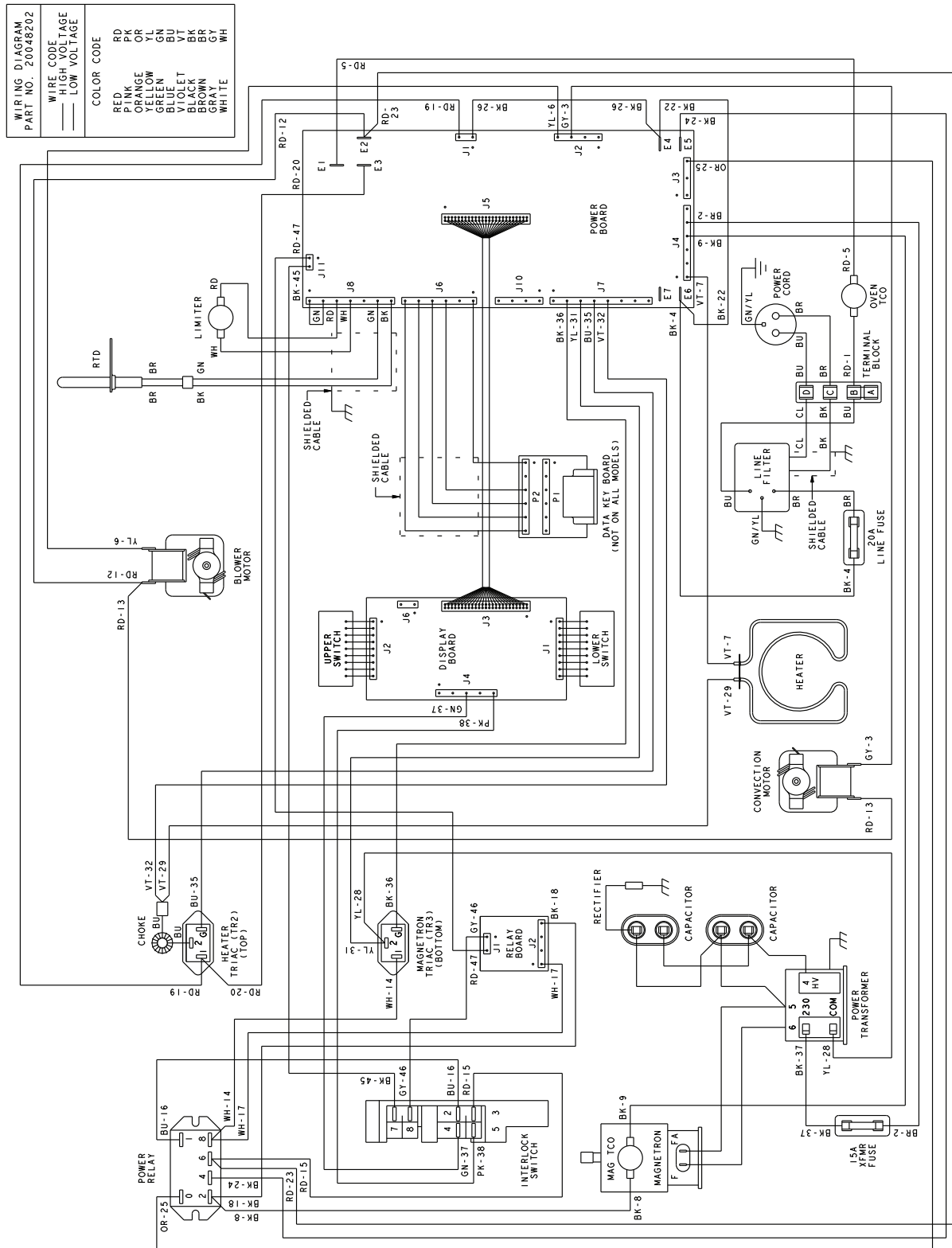

Schematic



WARNING

To avoid risk of electrical shock, personal injury, or death, disconnect power to oven and discharge capacitor before servicing, unless testing requires power.

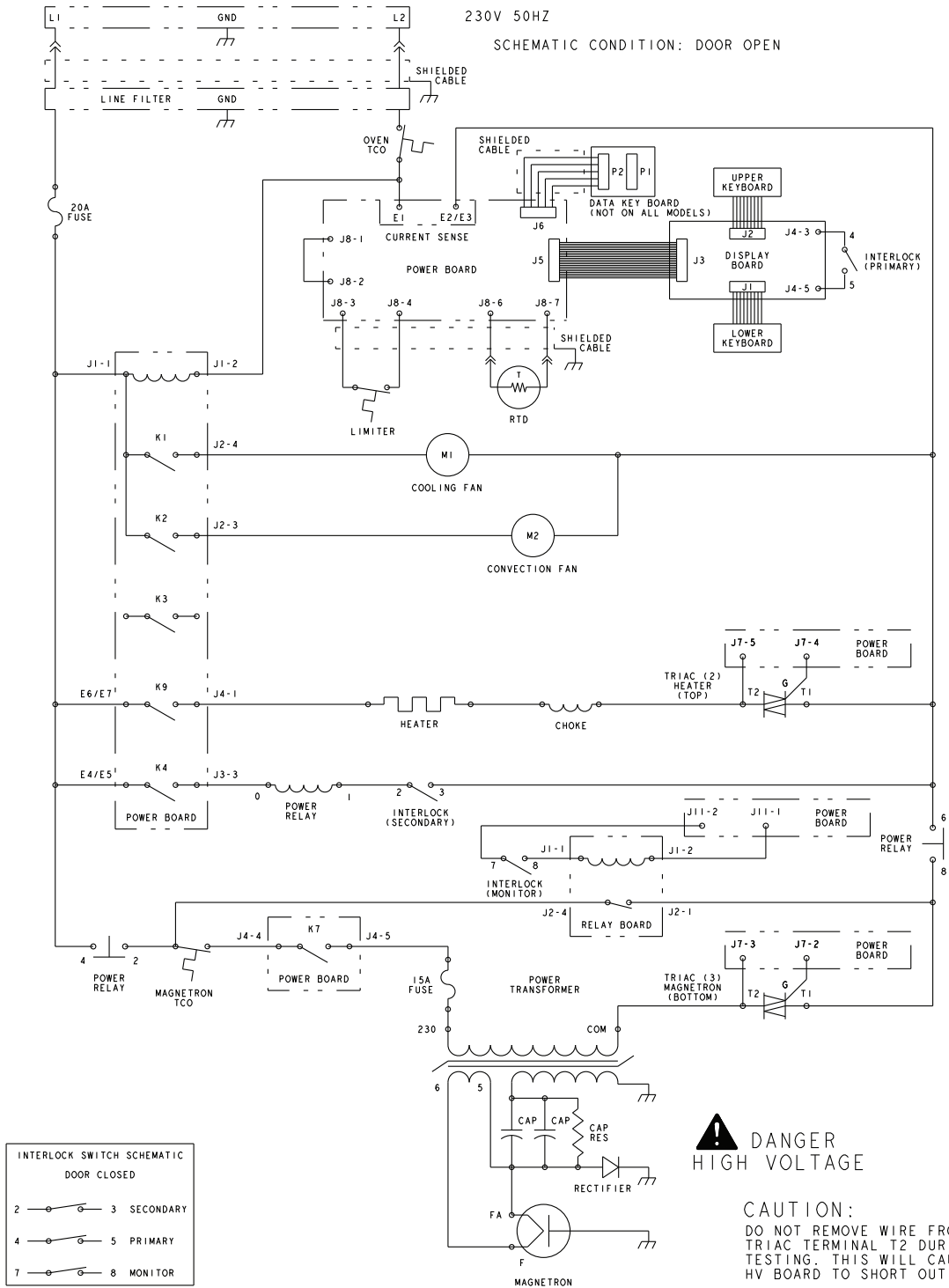

20048202

