

# International Commercial Microwave—Technical Information

## 230 V, 50 Hz Models

**DEC21E2**  
**MCHDC521**

**P1331247M**  
**P1331246M**

**HDC5212**

**P1331245M**

- Due to possibility of personal injury or property damage, always contact an authorized technician for servicing or repair of this unit.
- Refer to Service Manual RS5320013 for detailed installation, operating, testing, troubleshooting, and disassembly instructions.



### CAUTION

All safety information must be followed as provided in Service Manual RS5320013.



### WARNING



To avoid risk of electrical shock, personal injury, or death, disconnect power to oven and discharge capacitor before servicing, unless testing requires power.

Models	MCHDC521	DEC21E2 HDC5212
<b>Power Source</b>		
Voltage AC	230 VAC	230 VAC
Amperage (single unit)	16 A	16A
Frequency	50 Hz	50 Hz
Single phase, 3 wire earthed	X	X
Plug	Marechal DS3	CEE 7/7 Schuko
<b>Power Output</b>		
Nominal microwave energy (IEC705)	2100 Watts	2100 Watts
Minimum temperature rise ( $\Delta T$ )	21°F/11.5°C	21°F/11.5°C
Operating frequency	2450 MHz	2450 MHz
<b>Power Consumption</b>		
Cook condition microwave	3000 Watts	3000 Watts
<b>Dimensions</b>		
<b>Cabinet</b>		
Width	423 mm	423 mm
Height	335 mm	335 mm
Depth	578 mm	578 mm
<b>Oven Interior</b>		
Width	331 mm	331 mm
Height	175 mm	175 mm
Depth	305 mm	305 mm
<b>Weight</b>		
Crated	31 kg	31 kg

# Component Specifications

## ! WARNING

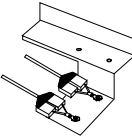
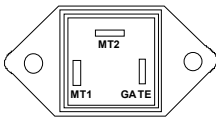
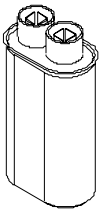
To avoid risk of electrical shock, personal injury, or death, disconnect power to oven and discharge capacitor before servicing, unless testing requires power.

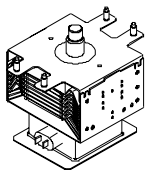
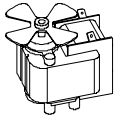
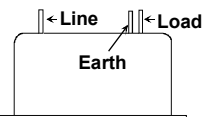
Illustration	Component	Testing	Results
	Thermal Cutout	Disconnect all wires from TCO. Measure resistance across terminals. Cavity Thermal Fuse..... Magnetron TCO .....	Open at 104° C (219° F). Open at 138° C (280° F) and closed at 82° C (180° F).
	Diode Assembly	<b>Discharge Capacitors</b>  Remove diode lead from capacitor and connect ohmmeter.  Reverse leads for second test.	Infinite resistance should be measured in one direction and 50KΩ or more in the opposite direction.  <b>NOTE:</b> Analog meter must contain a battery of 6 volts minimum.
	Triac	Disconnect wires to triac.  Measure resistance from: MT1 to MT2 ..... MT1 to Gate..... MT2 to Gate..... All terminals to ground .....	<b>Caution - Do not operate oven with wire to terminal MT2 removed.</b>  Infinite. Approximately 40 Ω or more. Infinite. Infinite.
	Capacitor	<b>Discharge Capacitors</b>  Remove wires from capacitor terminals and connect ohmmeter, set on highest resistance scale to terminals.  Also check between each terminal and capacitor case.	<b>Between Terminals:</b> Meter should momentarily deflect towards zero then return to over 5 MΩ. If no deflection occurs, or if continuous deflection occurs, replace capacitor.  <b>Terminal to Case:</b> Infinite resistance.
	Snubber Assembly	Disconnect wires to snubber.  Measure resistance across terminals.....	Infinite.
	Magnetron	<b>Discharge Capacitors</b>  Remove wires from magnetron and connect ohmmeter to terminals. Also check between each terminal and ground.	<b>Between Terminals:</b> Less than 1 Ω.  Each terminal to ground measures Infinite resistance. <b>NOTE:</b> This test is not conclusive. If oven does not heat and all other components test good replace the magnetron and retest.
	Blower Motor	Remove all wires from motor.  Measure resistance across coil.....	Approximately 30 Ω.
	Line Filter	Line to Line ..... Load to Load..... Line to Load..... Any terminal to Earth .....	.8 M Ω. .8 M Ω. Continuity. Infinite.
Wire Harness		Test continuity of wires .....	Continuity.

# Component Specifications

## ⚠ WARNING

To avoid risk of electrical shock, personal injury, or death, disconnect power to oven and discharge capacitor before servicing, unless testing requires power.

Illustration	Component	Testing	Results																																																
	Transformer	<p><b>Discharge Capacitor</b> Remove all wires from terminals, and measure resistance from:</p> <p>230 to Common.....</p> <p>Terminal 5 to 6 .....</p> <p>Terminal 7 to 8 .....</p> <p>Terminal 4 to Earth screw on transformer .....</p> <p>Terminal 4 to any other terminal .....</p>	<p>1 Ω. &lt;1 Ω. &lt;1 Ω. 38 Ω. Infinite resistance. If not, replace transformer.</p>																																																
	Stirrer motor 230 VAC	<p>Remove all wires from motor.</p> <p>Measure resistance across terminals .....</p>	Approximately 23 KΩ.																																																
	Interlock switch assembly	<p>Disconnect wires to switch.</p> <p>With door open measure resistance from:</p> <p>Terminal C to NO Primary .....</p> <p>Terminal C to NO Secondary .....</p> <p>Terminal C to NC Monitor .....</p> <p>With door closed measure resistance from:</p> <p>Terminal C to NO Primary .....</p> <p>Terminal C to NO Secondary .....</p> <p>Terminal C to NC Monitor .....</p> <p style="text-align: center;"><b>Door Closed</b></p> <p><b>Primary / Logic</b>    C — ● — ● — NO</p> <p><b>Monitor</b>            C — ● — ● — NC</p> <p><b>Secondary</b>         C — ● — ● — NO</p>	<p>Infinite. Infinite. Continuity.</p> <p>Continuity. Continuity. Infinite.</p>																																																
	Touch Panel Assembly	<p>Continuity is indicated as 100 Ω and below.</p> <p><b>Pin 1:</b> Ground.</p>	<table border="1"> <thead> <tr> <th>Pad</th> <th>Trace</th> <th>Measurement</th> </tr> </thead> <tbody> <tr><td>1</td><td>8 &amp; 10</td><td>Continuity</td></tr> <tr><td>2</td><td>7 &amp; 10</td><td>Continuity</td></tr> <tr><td>3</td><td>6 &amp; 10</td><td>Continuity</td></tr> <tr><td>4</td><td>5 &amp; 10</td><td>Continuity</td></tr> <tr><td>5</td><td>4 &amp; 10</td><td>Continuity</td></tr> <tr><td>6</td><td>3 &amp; 10</td><td>Continuity</td></tr> <tr><td>7</td><td>8 &amp; 9</td><td>Continuity</td></tr> <tr><td>8</td><td>7 &amp; 9</td><td>Continuity</td></tr> <tr><td>9</td><td>6 &amp; 9</td><td>Continuity</td></tr> <tr><td>0</td><td>5 &amp; 9</td><td>Continuity</td></tr> <tr><td>Start</td><td>4 &amp; 9</td><td>Continuity</td></tr> <tr><td>Stop/Reset</td><td>4 &amp; 8</td><td>Continuity</td></tr> <tr><td>Power Level</td><td>5 &amp; 8</td><td>Continuity</td></tr> <tr><td>X 2</td><td>6 &amp; 8</td><td>Continuity</td></tr> <tr><td>Time Entry</td><td>7 &amp; 8</td><td>Continuity</td></tr> </tbody> </table>	Pad	Trace	Measurement	1	8 & 10	Continuity	2	7 & 10	Continuity	3	6 & 10	Continuity	4	5 & 10	Continuity	5	4 & 10	Continuity	6	3 & 10	Continuity	7	8 & 9	Continuity	8	7 & 9	Continuity	9	6 & 9	Continuity	0	5 & 9	Continuity	Start	4 & 9	Continuity	Stop/Reset	4 & 8	Continuity	Power Level	5 & 8	Continuity	X 2	6 & 8	Continuity	Time Entry	7 & 8	Continuity
Pad	Trace	Measurement																																																	
1	8 & 10	Continuity																																																	
2	7 & 10	Continuity																																																	
3	6 & 10	Continuity																																																	
4	5 & 10	Continuity																																																	
5	4 & 10	Continuity																																																	
6	3 & 10	Continuity																																																	
7	8 & 9	Continuity																																																	
8	7 & 9	Continuity																																																	
9	6 & 9	Continuity																																																	
0	5 & 9	Continuity																																																	
Start	4 & 9	Continuity																																																	
Stop/Reset	4 & 8	Continuity																																																	
Power Level	5 & 8	Continuity																																																	
X 2	6 & 8	Continuity																																																	
Time Entry	7 & 8	Continuity																																																	

# Component Specifications



## WARNING

To avoid risk of electrical shock, personal injury, or death, disconnect power to oven and discharge capacitor before servicing, unless testing requires power

Illustration	Component	Testing	Results
	<p>Controller board</p> <p>P1 connector used for touch panel ribbon</p>	<p>Line voltage to control board P2 connector Pin 1—Pin 3.....</p> <p>Output drive voltage to triac Triac terminals..... Gate—T1 .....</p> <p>Fan relay (controls blower motor, antenna motor(s), and oven light) Control board .....</p> <p>Cook relay Control board .....</p>	<p>Line voltage (All Conditions).</p> <p>0 VAC (Idle and Standby). 0.9 VAC (Cook).</p> <p>Line voltage (Idle). 0 VAC (Standby and Cook).</p> <p>Line voltage (Idle). 0 volts (Standby and Cook).</p>

### Error Code Table

Error Code	Corrective Action
F1	Replace HV/LV Board
F2	Replace HV/LV Board
F3	Replace HV/LV Board
F4	Replace HV/LV Board
F5	Replace Touch Panel
F6	Replace HV/LV Board

### Usage Test

The Usage Test is used to access Magnetron Hours, Magnetron Cycles and Door Cycles. Use the following procedure to access the data:

1. Open door.
2. Press and hold pad **3** for five (5) seconds.  
NOTE: After five (5) seconds, SErv illuminates in the display.
3. Press pad **1** for Magnetron Hours.
4. Press pad **2** for Magnetron Cycles.
5. Press pad **3** for Door Cycles.

### Conditions

- Initial Power Up Condition: Apply power to oven with door closed.
- Idle Condition: Oven plugged in, display blank (no other components operating).
- Standby Condition: Open oven door, light and motors operate.
- Cook Condition: Food load in oven, cook cycle initiated.

# Component Specifications



## WARNING

To avoid risk of electrical shock, personal injury, or death, disconnect power to oven and discharge capacitor before servicing, unless testing requires power.

### Power Test

All Amana and Menumaster microwave oven power outputs are rated using the IEC705 standards. Using the IEC705 test method requires precision measurements and equipment that is not practical to be performed in the field. Using the test shown below will indicate if the oven performance is satisfactory.

#### Test equipment required:

- 1000 ml test container and thermometer (Amana power test kit R0157397 Fahrenheit / Menumaster power test kit M95D5 Celsius).
- Digital watch / watch with a second hand for use on ovens with electromechanical timers.

#### Important Notes:

- Low line voltage will cause low temperature rise / power output.
- Ovens must be on a dedicated circuit, properly grounded, and polarized. Other equipment on the same circuit may cause a low temperature rise / power output.
- This test and results are not a true IEC705 test procedure and are only intended to provide servicers with an easy means of determining if the microwave oven cooking output is correct.

### Procedure

1. Fill the test container to the 1000 ml line with cool tap water.

**NOTE:** Water temperature should be approximately 60° F / 16° C.

2. Using the thermometer, stir water for five to ten seconds; measure, and record the temperature (T1).
3. Place test container of water in the center of oven cavity and close door.
4. Heat the water for a 33-second full power cycle.

**NOTE:** Use a digital watch or a watch with a second hand for ovens with electromechanical timers.

1. At end of the cycle, remove test container. Using the thermometer, stir water for five to ten seconds and record temperature (T2).
2. Subtract the starting water temperature (T1), from the ending water temperature (T2) to obtain the temperature rise ( $\Delta T$ ).
3. If the temperature rise ( $\Delta T$ ) meets or exceeds the minimum, the test is complete. If the temperature rise ( $\Delta T$ ) fails to meet the minimum temperature rise, test the line voltage to verify it is correct. Then repeat steps 1-6 making sure to change the water. If the temperature rise ( $\Delta T$ ) fails to meet the minimum temperature rise again the oven will require service.

#### Minimum Temperature Rise at Thirty-Three (33) Seconds Run Time

$\Delta T$ (°F)	Cooking Power Output	$\Delta T$ (°F)	Cooking Power Output	$\Delta T$ (°C)	Cooking Power Output	$\Delta T$ (°C)	Cooking Power Output
10.....	1000	20.....	2000	5.....	1000	11.....	2000
11.....	1100	21.....	2100	5.5.....	1100	11.5.....	2100
12.....	1200	22.....	2200	6.5.....	1200	12.....	2200
14.....	1400	24.....	2400	7.5.....	1400	13.....	2400
17.....	1700	25.....	2500	9.5.....	1700	13.5.....	2500
18.....	1800	27.....	2700	10.....	1800	15.....	2700
19.....	1900	30.....	3000	10.5.....	1900	16.5.....	3000

# Wiring and Schematic Diagrams



## WARNING

To avoid risk of electrical shock, personal injury, or death, disconnect power to oven and discharge capacitor before servicing, unless testing requires power.

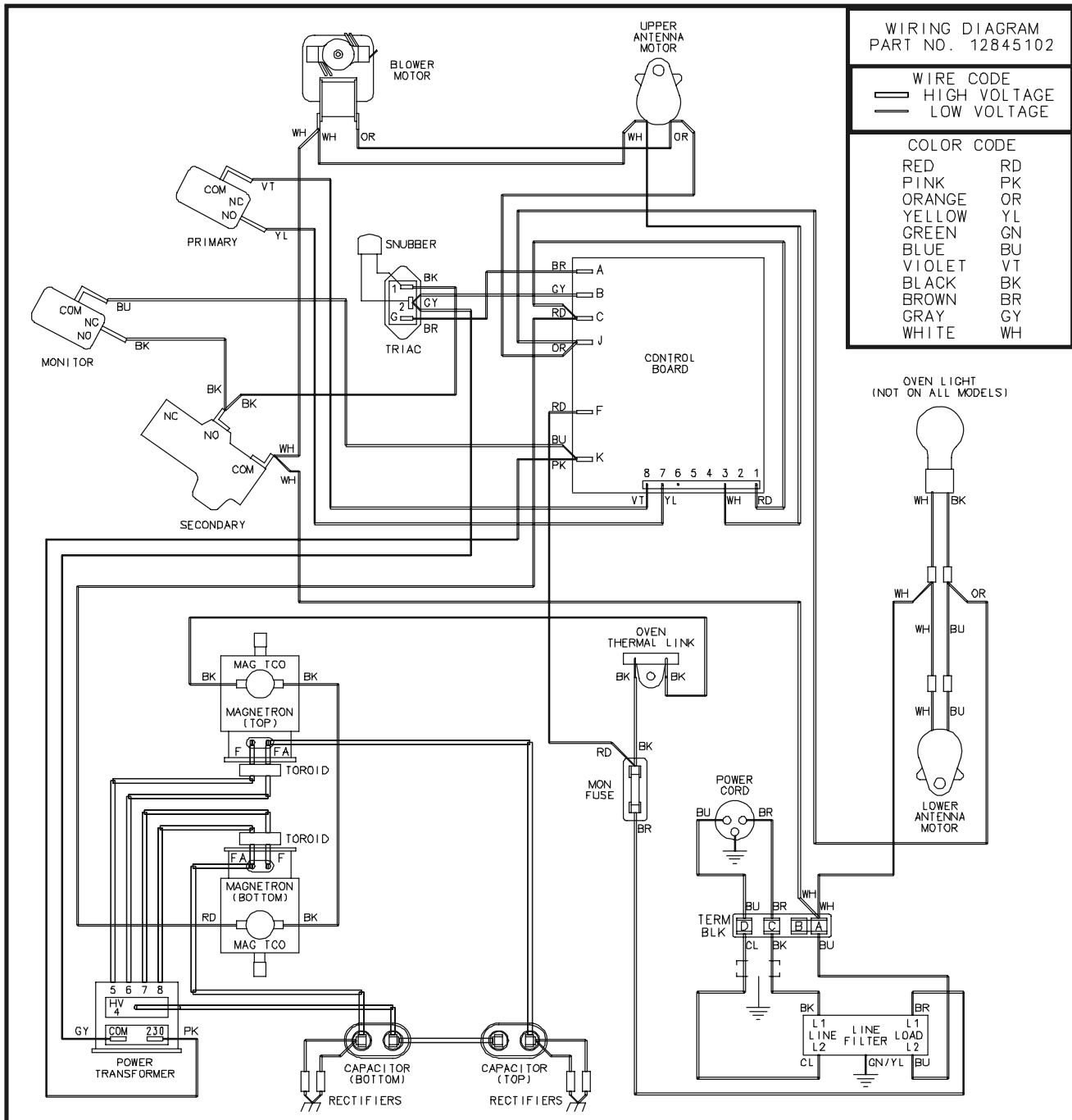

12845102

DEC21E2  
MCHDC521

HDC5212

# Wiring and Schematic Diagrams



## WARNING

To avoid risk of electrical shock, personal injury, or death, disconnect power to oven and discharge capacitor before servicing, unless testing requires power.

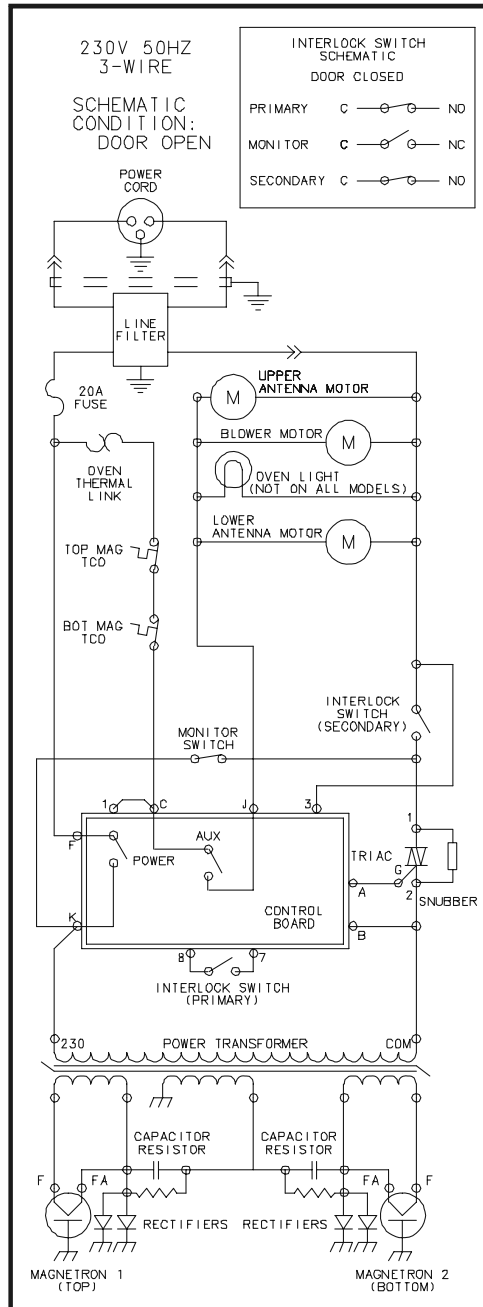

12845102



DANGER

HIGH VOLTAGE

DEC21E2  
MCHDC521

HDC5212