

International Commercial Microwave—Technical Information

240/230 VAC, 50 Hz Models

RC5KFT2 P1332833M

RC5MDTS2 P1332835M

RC5MDTM2 P1332836M

- Due to possibility of personal injury or property damage, always contact an authorized technician for servicing or repair of this unit.
- Refer to Service Manual 16022149 for installation, operating, testing, troubleshooting, and disassembly instruction.



CAUTION

All safety information must be followed as provided in Service Manual 16022149.



WARNING

To avoid the risk of electrical shock, personal injury or death; disconnect power to oven and discharge capacitor before servicing, unless testing requires power.



Models	RC5KFT2	RC5MDTS2	RC5MDTM2
Power Source			
Voltage AC	230/240 VAC	230/240 VAC	230/240 VAC
Amperage (Single Unit)	16 A	32 A	32 A
Frequency	50 Hz	50 Hz	50 Hz
Single Phase, 3 wire grounded	X	X	X
Plug	CEE 7/7Schuko	IEC309-32A	Marechal DS3
Power Output - Microwave			
Nominal microwave energy (IEC705)	1800 Watts	2400 Watts	2400 Watts
Minimum temperature rise (ΔT)	18°F / 10°C	24°F / 13°C	24°F / 13°C
Operating Frequency	2450 MHz	2450 MHz	2450 MHz
Power Consumption			
Microwave only	2950 Watts / 12.8 A	3900 Watts / 17 A	3900 Watts / 17 A
Dimensions			
Cabinet (cm in)			
Width	49 cm 19 1/4"	49 cm 19 1/4"	49 cm 19 1/4"
Height	46 cm 18 1/4"	46 cm 18 1/4"	46 cm 18 1/4"
Depth	67 cm 26 1/4"	67 cm 26 1/4"	67 cm 26 1/4"
Oven Interior (cm in)			
Width	33 cm 13"	33 cm 13"	33 cm 13"
Height	22 cm 8 1/2"	22 cm 8 1/2"	22 cm 8 1/2"
Depth	38 cm 15"	38 cm 15"	38 cm 15"
Weight (kg lbs)			
Uncrated	52 kg 115 lbs.	52 kg 115 lbs.	52 kg 115 lbs.
Crated	56 kg 123 lbs.	56 kg 123 lbs.	56 kg 123 lbs.

Component Testing Procedures

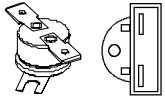
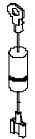
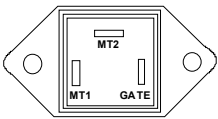
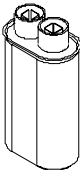

WARNING

To avoid risk of electrical shock, personal injury or death; disconnect power to oven and discharge capacitor before servicing, unless testing requires power.

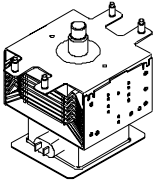
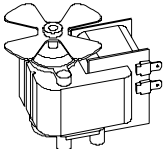
Illustration	Component	Test	Results
	Thermal cutout	Disconnect all wires from TCO. Measure resistance across terminals. Magnetron TCO..... Cavity TCO.....	Open at 149° C (300° F) and closed at 125° C (257° F). Opens at 128° C (262° F).
	Diode	Discharge Capacitor Remove diode lead from capacitor and connect ohmmeter. Reverse leads for second test.	Infinite resistance should be measured in one direction and 50KΩ or more in the opposite direction. NOTE: Ohmmeter must contain a battery of 6 volts minimum.
 Triac 1 (center) Triac 2 (left) Triac 3 (right)	Triac	Resistance Check Disconnect wires to triac. Measure resistance from: MT1 to MT2..... MT1 to Gate..... MT2 to Gate..... All terminals to ground.....	Caution - Do not operate oven with wire to terminal MT2 removed. Infinite. Approximately 60 Ω. Infinite. Infinite.
		Voltage Check Measure voltage from: MT1 to Gate	0.8 VAC when energized. If no voltage, check H.V. board and wiring.
	Capacitor Some units may use more than one type of capacitor. Refer to Parts Manual for correct capacitor quantity.	Discharge Capacitor Remove wires from capacitor terminals and connect ohmmeter, set on highest resistance scale to terminals. Also check between each terminal and capacitor case.	Between Terminals: Meter should momentarily deflect towards zero then return to over 5 MΩ. If no deflection occurs, or if continuous deflection occurs, replace capacitor. Terminal to Case: Infinite resistance.
	Snubber assembly	Disconnect wires to snubber. Measure resistance across terminals.....	Infinite.
	Magnetron	Discharge Capacitor Remove wires from magnetron and connect ohmmeter to terminals. Also check between each terminal and ground.	Between Terminals: Less than 1 Ω. Each terminal to ground measures Infinite resistance. NOTE: This test is not conclusive. If oven does not heat and all other components test good replace the magnetron and retest.
	Blower motor	Remove all wires from motor. Measure resistance across coil.....	Approximately 25 Ω.

Component Testing Procedures



WARNING

To avoid risk of electrical shock, personal injury or death; disconnect power to oven and discharge capacitor before servicing, unless testing requires power.

Illustration	Component	Test	Results
	Transformer 	Discharge Capacitor Remove all wires from terminals. Measure resistance from: 230 to COM 230 to Ground..... Terminal 5 to 6..... Terminal 4 to Ground.....	Less than 1 Ω. Infinite. Less than 1 Ω. Approximately 65 Ω.
	Interlock switch Door Closed 2 — 3 Secondary 4 — 5 Primary 7 — 8 Monitor	Disconnect wires to switch. With door open measure resistance from: Terminal 2 to 3..... Terminal 4 to 5..... Terminal 7 to 8..... With door closed measure resistance from: Terminal 2 to 3..... Terminal 4 to 5..... Terminal 7 to 8.....	Infinite. Infinite. Indicates continuity. Indicates continuity. Indicates continuity. Infinite.
	Lamp receptacle (some models)	Test continuity of receptacle terminals.	Indicates continuity if bulb is good and screwed in.
	Antenna motor	Remove all wires from terminals. Measure resistance from: Terminal to terminal.....	Approximately 12K Ω.
	Relay This relay contains a diode in the coil circuit.	Measure resistance from: Terminal 0 to terminal 1 (coil)..... 	Approximately 6 to 7 MΩ.
	Line filter	Disconnect wire from terminals. Measure resistance of the following terminals: White to Blue Black to Brown.....	< 1 Ω < 1 Ω
	Terminal block	Visual check.	Verify fuse holding terminals are not damaged. Verify terminals are not damaged.
Refer to Parts Manual for proper power cord part number.	Power cord	Measure resistance of wires.	Continuity should be indicated on each wire. Verify polarity and grounding.

Component Testing Procedures

⚠ WARNING

To avoid risk of electrical shock, personal injury or death; disconnect power to oven and discharge capacitor before servicing, unless testing requires power.

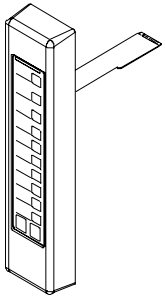
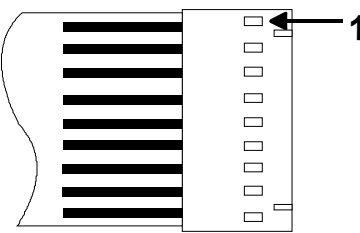
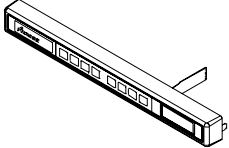
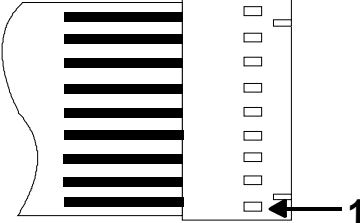
Illustration	Component	Test	Results		
	Side touch panel	Continuity is indicated as 100 Ω and below. 	Pad 1 2 3 4 5 6 7 8 9 0 Start Stop/Reset	Trace 3 & 5 3 & 6 3 & 7 3 & 8 3 & 9 4 & 5 4 & 6 4 & 7 4 & 8 4 & 9 5 & 6 6 & 9	Measurement Continuity Continuity Continuity Continuity Continuity Continuity Continuity Continuity Continuity Continuity Continuity Continuity
	Top touch panel	Removal of touch panel is required to perform test. Continuity is indicated as 100 Ω and below. 	Pad Time Entry Power Level Stage Program Save Quantity Menu Hidden Pad	Trace 5 & 7 5 & 8 5 & 9 6 & 7 6 & 8 7 & 9 8 & 9	Measurement Continuity Continuity Continuity Continuity Continuity Continuity Continuity

Display board

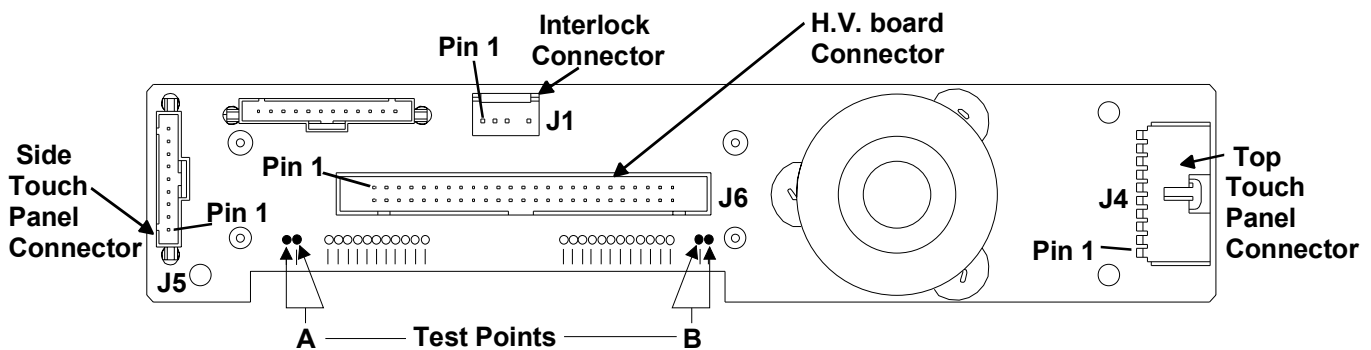

Function	Test Set-Up	Meter Setting	Probe Placement	Results
Input to Display Board	At Display Board	Volts	Test points A and B	3.0 VAC If voltage is present and no display is indicated, replace display board. If no voltage is present, check wire harness connections and H.V. board.

Component Testing Procedures

⚠ WARNING

To avoid risk of electrical shock, personal injury or death; disconnect power to oven and discharge capacitor before servicing, unless testing requires power.

H.V. board

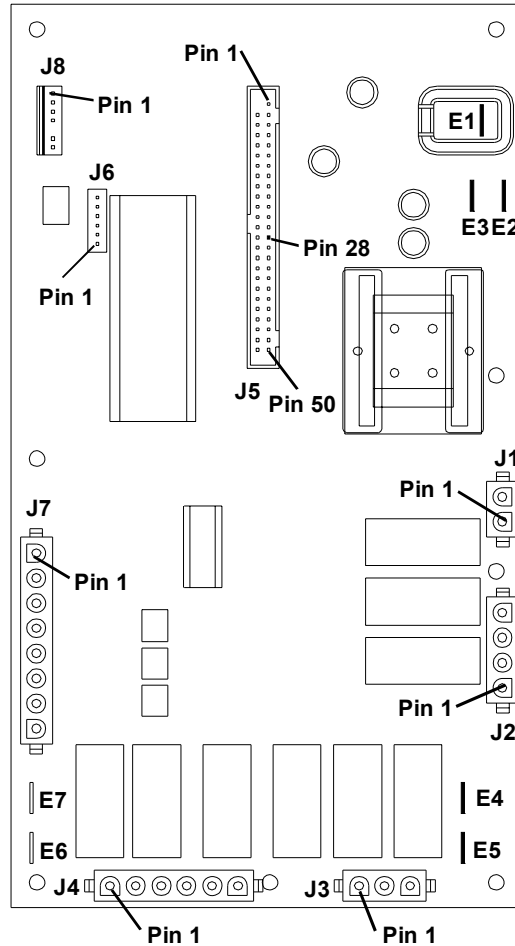

Function	Test Set-Up	Meter Setting	Probe Placement	Results
Input to H.V. board	At H.V. board	Volts	J1 pin 1 (Brown wire) & J1 pin 2 (White wire)	Line voltage.
Output to display board	Disconnect J5 connector, blower runs continuously	Volts	J5 pin 28 & J5 pin 50	- 24 VDC.

NOTE: For the following test, place oven in Service Test Mode (see page 10).

Relay	Function	Test Set-Up	Meter Setting	Probe Placement	Results
K1 at 230 VAC line voltage	Blower motor Antenna motor Cavity light	Disconnect J2 connector	Ohms	J1 pin 1 (Brown wire) & J2 pin 4	Test mode 5 off - no continuity. Test mode 5 on - < 1 Ω.

Component Testing Procedures

⚠ WARNING

To avoid risk of electrical shock, personal injury or death; disconnect power to oven and discharge capacitor before servicing, unless testing requires power.

H.V. Board - Relay Test

Three Magnetron Models

Relay	Function	Test Set-Up	Meter Setting	Probe Placement	Results
K8	Magnetron 1 (Top rear) at 230 VAC	All wires connected to H.V. board	VAC	E2 (Black wire) & J4 pin 2 (Red wire)	Test mode 1 off - line voltage. Test mode 1 on - 0 volts.
K4	Magnetron 2 (Top front) at 230 VAC	All wires connected to H.V. board	VAC	E5 (Red wire) & J3 pin 1 (Gray wire)	Test mode 2 off - line voltage. Test mode 2 on - 0 volts.
K6	Magnetron 3 (Bottom) at 230 VAC	All wires connected to H.V. board	VAC	J4 pin 4 (Black wire) & J4 pin 6 (Black wire)	Test mode 3 off - line voltage. Test mode 3 on - 0 volts.

“CALL SERV” — Will appear in the display when there is a fault occurring with the unit. After servicing the unit, the servicer must reset the service code to remove **“CALL SERV”** from the display.

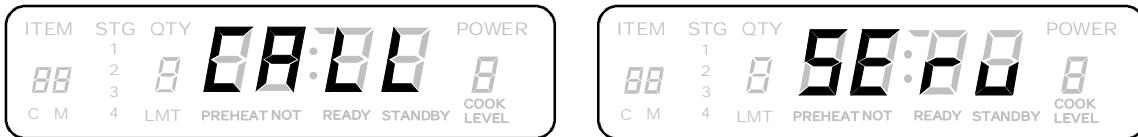

The display will then be OFF for 5 seconds

Unit must be in OFF condition
or
INITIAL power up mode.
Oven door must be closed.



NOTE: Pads will not beep when accessing Service Test Mode.

Press Hidden Pad.

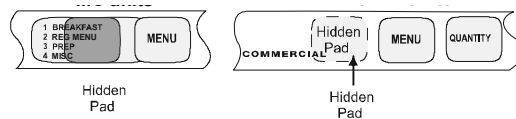

Then **1 3 5 7 9**

Display will indicate the Service Test Mode.



1. Enter Service Code by pressing the following pads in order shown: **HIDDEN ENABLE** pad, **1** pad, **3** pad, **5** pad, **7** pad, and **9** pad.
2. Press **0** pad to clear **“CALL SERV”** from the display. Display will indicate **“C L r”**.
3. Press STOP/RESET pad to exit Service Test Mode.

Component Testing Procedures

WARNING

To avoid risk of electrical shock, personal injury or death; disconnect power to oven and discharge capacitor before servicing, unless testing requires power.

Three Magnetron Models

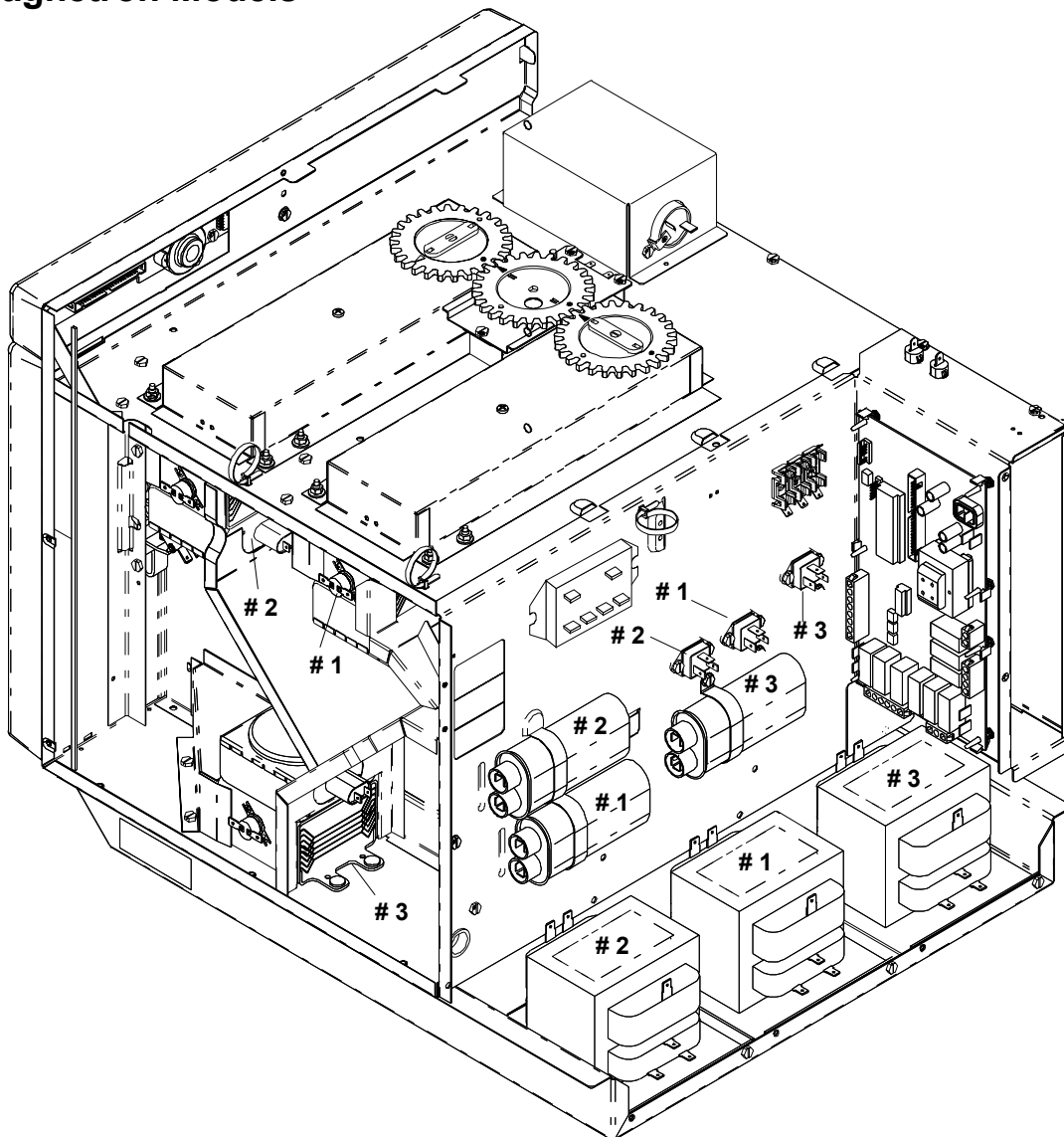

H.V. System # 1	H.V. System # 2	H.V. System # 3
Top Rear Magnetron Center Transformer Bottom Center Capacitor Diode Center Triac	Top Front Magnetron Left Transformer Top Left Capacitor Diode Left Triac	Bottom Magnetron Right Transformer Right Capacitor Diode Right Triac

Power Testing Procedure



WARNING

To avoid risk of electrical shock, personal injury or death; disconnect power to oven and discharge capacitor before servicing, unless testing requires power.

All Amana and Menumaster microwave oven power outputs are rated using the IEC705 standards. Using the IEC705 test method requires precision measurements and equipment that is not practical to be performed in the field. Using the test shown below will indicate if the oven performance is satisfactory.

Test equipment required:

- 1000 ml test container and thermometer (Amana power test kit R0157397 Fahrenheit / Menumaster power test kit M95D5 Celsius).
- Digital watch / watch with a second hand for use on ovens with electromechanical timers.

Important Notes:

- Low line voltage will cause low temperature rise / power output.
- Ovens must be on a dedicated circuit, properly grounded, and polarized. Other equipment on the same circuit may cause a low temperature rise / power output.
- This test and results are not a true IEC705 test procedures and are only intended to provide servicers with an easy means of determining if the microwave oven cooking output is correct.

Procedure

1. Fill the test container to the 1000 ml line with cool tap water.

NOTE: Water temperature should be approximately 60° F / 16° C.

2. Using the thermometer, stir water for five to ten seconds; measure, and record the temperature (T1).
3. Place test container of water in the center of oven cavity and close door.
4. Heat the water for a 33-second full power cycle.

NOTE: Use a digital watch or a watch with a second hand for ovens with electromechanical timers.

5. At end of the cycle, remove test container. Using the thermometer, stir water for five to ten seconds and record temperature (T2).
6. Subtract the starting water temperature (T1) from the ending water temperature (T2) to obtain the temperature rise (ΔT).
7. If the temperature rise (ΔT) meets or exceeds the minimum, the test is complete. If the temperature rise (ΔT) fails to meet the minimum temperature rise, test the line voltage to verify it is correct. Then repeat steps 1 - 6 making sure to change the water. If the temperature rise (ΔT) fails to meet the minimum temperature rise again the oven will require service.

Minimum Temperature Rise at Thirty -Three (33) Seconds Run Time

ΔT (°F)	Cooking Power Output	ΔT (°F)	Cooking Power Output	ΔT (°C)	Cooking Power Output	ΔT (°C)	Cooking Power Output
10.....	1000	20	2000	5	1000	11	2000
11.....	1100	21	2100	5.5.....	1100	11.5.....	2100
12.....	1200	22	2200	6.5.....	1200	12	2200
14.....	1400	24	2400	7.5.....	1400	13	2400
17.....	1700	25	2500	9.5.....	1700	13.5.....	2500
18.....	1800	27	2700	10	1800	15	2700
19.....	1900	30	3000	10.5.....	1900	16.5.....	3000

Diagnostics Procedures



WARNING

To avoid risk of electrical shock, personal injury or death; disconnect power to oven and discharge capacitor before servicing, unless testing requires power.



CAUTION

All repairs as described in this troubleshooting section are to be performed only after the caution procedures one through eight listed below have been followed.

1. Check grounding before checking for possible causes.
2. Be careful of the high voltage circuit.
3. Discharge high voltage capacitor.
4. When checking the continuity of the switches or the high voltage transformer, disconnect one lead wire from these parts and then check continuity with the AC plug removed. To do otherwise may result in a false reading or damage to your meter.
5. Do not touch any parts of the circuitry on the P.C. Board circuit since static electric discharge may damage this control panel. Always touch yourself to ground while working on this panel to discharge any static charge in your body.
6. 240/230 VAC is present in the high voltage circuit board, power relay and primary circuit of low voltage transformer.
7. When troubleshooting, be cautious of possible electrical hazard.
8. When testing convection operation, convection fan may start at any time or if oven is hot.

Error Codes

During operation, the display may show the following service codes:

NOTE: Before scheduling service for any error codes, instruct customer to unplug oven for 1 minute, reconnect power, and retest. If unit operates properly, no service call is required.

Display	Description	Corrective Action
Err1	Failed H.V. Board	Replace H.V. board.
Err2	Failed H.V. Board Shorted Touch Panel Shorted Display Board Shorted Cable HV to Display Board	Replace H.V. board. Replace Touch Panel. Replace Display Board. Replace Cable.
Err3	Failed H.V. Board	Replace H.V. board.
Err4	Failed H.V. Board	Replace H.V. board.
Err5	Shorted Touch Panel	NOTE: If Touch Panel is pressed for more than 30 seconds, this error code will appear. 1. Disconnect oven from power supply. 2. Disconnect side touch panel connector from display board (J5). 3. Reconnect oven to power supply. 4. If "Err5" reappears after 30 seconds, replace top touch panel. 5. If "Err5" does not reappear after 30 seconds, replace side touch panel.
Err6	Failed H.V. Board	Replace H.V. board.
HOT		<ul style="list-style-type: none"> • Open TCO (magnetron). • Blower motor inoperative. • Restricted air filter. • H.V. board inoperative. • High ambient temperature. • Oven operated empty or with light loads. • Broken or loose wire.
Door	Door Interlock Primary Switch	<ul style="list-style-type: none"> • Verify latch mechanism moves freely on door. • Verify J1 connector on display board is properly seated. • Test interlock switch assembly and perform door adjustment if necessary. • Replace interlock switch assembly.
CALL SErv	Amperage monitoring System on H.V. Board	<ul style="list-style-type: none"> • Power interruption while oven is operating may cause this code to display when power is restored. • Reset CALL SErv , Service Test procedure – Pad "0". • Place water load inside cavity and use pre-programmed pad to operate oven for 30 seconds or more. <ul style="list-style-type: none"> • If CALL SErv does not appear, no further repairs are necessary. • If CALL SErv reappears, use Service Test procedure to operate each H.V. system independently to isolate fault. <ul style="list-style-type: none"> • Replace H.V. Board If Call SErv display will not clear. • Reset CALL SErv after fault has been corrected.

Service Test

NOTE: Unit must be in OFF condition or INITIAL power up mode.



To Enter Service Test Mode, oven door must be closed.

NOTE: Pads will not beep when accessing Service Test Mode. To EXIT Service Test Mode press STOP/RESET pad.

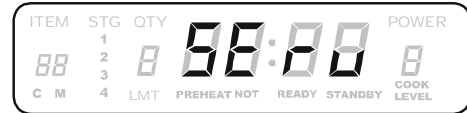
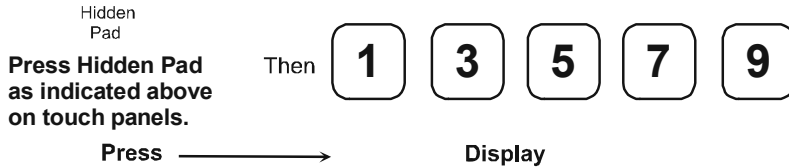
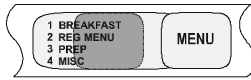

High Voltage System # 1

1

Toggles Magnetron 1 (Top Rear) ON/OFF.

Displays actual Amperage, will vary by model



Timer counts up to 62 seconds and unit shuts off.

If no Amperage, check for line voltage at H.V. transformer primary winding.

If no voltage, check:

- Interlock switch (secondary)
- Triac 1
- H.V. board (relay K8 if 230 VAC, and triac 1 drive voltage T1 - G)
- Wiring

If voltage is present, check:

- H.V. components and wiring.

High Voltage System # 2

2

Toggles Magnetron 2 (Top Front) ON/OFF.

Displays actual Amperage, will vary by model



Timer counts up to 62 seconds and unit shuts off.

If no Amperage, check for line voltage at H.V. transformer primary winding.

If no voltage, check:

- Interlock switch (secondary)
- Triac 2
- H.V. board (relay K4 if 230 VAC, and triac 2 drive voltage T1 - G)
- Wiring

If voltage is present, check:

- H.V. components and wiring.

High Voltage System # 3

3

Toggles Magnetron 3 (Bottom) ON/OFF.

Displays actual Amperage, will vary by model

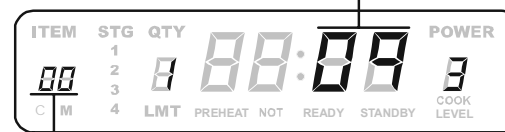

Timer counts up to 62 seconds and unit shuts off.

If no Amperage, check for line voltage at H.V. transformer primary winding.

If no voltage, check:

- Interlock switch (secondary)
- Triac 3
- H.V. board (relay K6 if 230 VAC, and triac 3 drive voltage T1 - G)
- Wiring

If voltage is present, check:

- H.V. components and wiring.

Service Test

Press →

Display

Component Evaluation

4

NOT ACTIVE



- This mode is NOT active with these models.

5

Toggles
Blower Motor
Antenna Motor(s)
Cavity Light (if applicable)
ON/OFF.



- If no fan operation, check:
- Blower motor and wheel
 - Antenna motor
 - Cavity light (if applicable)
 - H.V. board relay K1 - 230 V relay K2 - 208V
 - Wiring

6

NOT ACTIVE



- This mode is NOT active with these models.

7

Displays # of
Magnetron Hours.



8

Displays # of Door Cycles
with a 1 to 1 ratio rounded
to the nearest ten



9

Clears Hours and Cycles
(press START to activate)
(Resets to 0).



0

Pressing 0 will clear
CALL SERVICE display.



- CALL is displayed for 1 second
SERV is displayed for 1 second.
Then the display will be OFF for 5 seconds.
- This will continue until
Call Service is cleared
from the display.

Wiring Diagram and Schematic



WARNING

To avoid risk of electrical shock, personal injury or death; disconnect power to oven and discharge capacitor before servicing, unless testing requires power.

